

Version 5.0

## Discrete and standard IC product guide

# Discrete and standard IC product guide

Zetex Semiconductors is a specialist in analog technology.

We design and manufacture semiconductor solutions for the management of power and analog signals in high performance products.

Zetex is a long-standing supplier of industry leading bipolar discrete components and linear ICs and the current products are detailed in this selection guide.

## Application specific products

As well as our experience in discrete and linear ICs, Zetex produces a range of application specific products that meet the requirement for greater power efficiency, precision and speed in LED driving, audio power amplifier and satellite applications.

Further information on these products is available on request.



### High efficiency, cost effective LED driving

A comprehensive range of LED drivers for a wide variety of application sectors.

- Buck, boost and buck / boost configurations
- Efficiencies of up to 95%
- Capable of driving 1- 16 high power LEDs
- Simple and practical in use



### High performance digital and analog Class D amplifier technology

Advanced signal processing chipsets delivering the needs of advanced AV entertainment systems

- Optimum audio performance
- High energy efficiency for low power consumption
- Flexible processing platform supports a broad range of power levels and channel formats



### Meeting the challenges of Direct Broadcast by Satellite ('DBS')

System focused solutions for signal and power management

- Highly integrated products
- Reduced size and system cost
- Lowest LNB power consumption
- Reliability in extreme environments

Contact Zetex for further information or see [www.zetex.com](http://www.zetex.com)

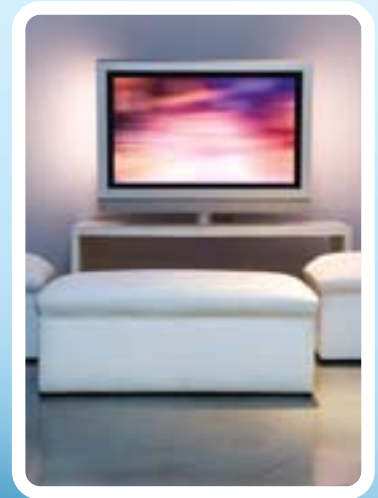

Version 5.0

## Discrete and standard IC product guide

# Discrete and standard IC product guide

## Discrete semiconductors

As an expert in the management of power, Zetex Semiconductors provides product designers with a broad range of discrete semiconductor components that are renowned for their quality, high performance and optimized packaging.

With its leading edge bipolar technology, Zetex has long set the benchmark for bipolar transistor performance with very low saturation voltages and high power density components.

Concise product data for the complete range of bipolar transistors, diodes and MOSFETs is presented in this selection guide.

## Standard ICs

The best power management ICs provide circuit designers with the most advantageous combination of efficiency, functionality and package size.

Zetex Semiconductors is able to offer a portfolio of devices that meet the requirements of a wide range of electronic applications by addressing these competing design criteria to produce elegant and practical solutions,

As an expert in power management, Zetex works closely with customers and partners to define the precise needs of a particular application and to identify the most appropriate integrated solution.

With its knowledge and technology leadership, Zetex has created the range of innovative and competitive power management ICs presented here.





**Quality assurance,  
environmental and RoHS  
compliance**

Emphasizing its ongoing commitment to product quality, Zetex enjoys corporate status as an ISO/TS 16949:2002 certified company - the industry's most comprehensive quality management standard for companies operating in the global automotive procurement chain.

This award enhances the company's worldwide operation as a recognized ISO 9001:2000 supplier and is complemented by Zetex gaining ISO14001 certification in March 2006.

ISO14001 is the standard that forms the cornerstone of today's emerging environmental practices for responsible industrial management.

Certification to all of these management systems underlines Zetex' determination to harmonize products and processes to satisfy international quality, environmental standards and customer requirements, while seeking to minimize any adverse environmental impact.

The restriction on the use of certain hazardous substances (RoHS) legislation currently poses designers and manufacturers with yet another hurdle in bringing products to market.

As an active supporter of environmentally friendly practices, Zetex began conversion of its portfolio to RoHS compliance early in 2003.

All Zetex products are now available in a RoHS compliant format, without any changes to performance or specification.

For more information, visit [www.zetex.com/leadfree](http://www.zetex.com/leadfree)



# Contents

## 1.0 Bipolar transistors

Bipolar transistors up to 500V	8	Dual NPN and PNP transistors	30
NPN Avalanche transistors	28	Transistor and Schottky diode combinations	31
NPN & PNP Darlington transistors	28	Gate Drive transistors	32
H-bridges	29	Article	34
NPN/PNP combinations	29		

## 2.0 Diodes

Schottky Diodes	38	Power diodes	40
Varactor (tuner) diodes	39		

## 3.0 MOSFETs

20V devices	42	80V to 100V devices	48
30V to 50V devices	43	150V to 450V devices	49
60V to 70V devices	45		

## 4.0 Current monitors

Current output current monitors	54
Voltage output current monitors	56

## 5.0 Voltage references

Shunt regulators	59	Industry standard references	61
Micro-power voltage regulators	60		

## 6.0 Linear regulators

Miniature linear regulators	64	Ultra-low dropout regulators	66
Industry standard improved regulators	65	Micro-power low dropout regulators	67

## 7.0 DC-DC boost converters

Low power DC-DC boost converters	69	Transistors and Schottky diode combinations	71
Single and multi-cell system power boost controllers	70		

## 8.0 Special functions

Supply voltage monitors (uP generators)	73	Temperature sensor	74
Siren Driver	74	Magneto-resistive sensors	75

## 9.0 Package information

Package information	76
Thermal data	82

## 10.0 Alphanumeric index

# Bipolar transistors

## Section 1.0

**Today's portable devices demand power switches that can operate efficiently within limited power supply headroom. The combination of low saturation voltages, high gain, and low voltage drive characteristics that bipolars offer makes them the natural choice for operation at the 5V level and below. Add their ruggedness and low thermal resistance within minimal footprints and it's easy to see why bipolars can also outperform MOSFETs in higher voltage applications that range from automotive power converters to telecomms interfaces.**

Zetex Semiconductors offers a portfolio of bipolar products that builds on successive generations of process know-how, leading edge design and innovation to manage voltages up to 500V with maximum efficiency. Its latest range of products extends the company's leadership in building ultra-low saturation voltage bipolar transistors that permit ever smaller surface mount packages to control continuous currents of several amps.

Crucially, the specific die-area resistance of these bipolar transistors is significantly less than that of competing MOSFETs, and is especially suited to operation within cost sensitive, power-conscious, and space-constrained portable applications. For a more in-depth comparison of bipolar and MOSFET technology read the article at the back of the Discrete Component section of this brochure.

Multichip devices that combine transistors and Schottky diodes within leadless QFN packages are also available from Zetex to conserve valuable space in high-density assemblies. These devices especially suit charger circuits, DC-DC converters, MOSFET gate drivers, and motor control applications in mobile and portable equipment.

High voltage applications such as backlight inverters, motor drivers, and subscriber-line interface cards also benefit from bipolar transistor technology. Here too the bipolar's low saturation voltage challenges MOSFETs in low to medium current applications, and the availability of surface mount packages that dissipate up to 3W in SOT223 outline further promotes overall design efficiency.





# Contents

<b>Devices up to 25V</b>			
NPN transistors	10-12	<b>NPN Darlington transistors</b>	28
PNP transistors	13-15	<b>PNP Darlington transistors</b>	28
<b>Devices from 30 to 50V</b>		<b>H-bridges</b>	29
NPN transistors	16-17	<b>NPN/PNP combinations</b>	29
PNP transistors	18-19	<b>Dual NPN transistors</b>	30
<b>Devices from 55 to 100V</b>		<b>Dual PNP transistors</b>	30
NPN transistors	20-21	<b>Transistor and Schottky diode combinations</b>	31
PNP transistors	22-23	<b>Gate drive transistors</b>	32
<b>Devices from 120 to 220V</b>		<b>Article: Applications dictate bipolar or MOSFET power switch choices</b>	34
NPN transistors	24		
PNP transistors	25		
<b>Devices from 300 to 500V</b>			
NPN transistors	26		
PNP transistors	27		
<b>NPN avalanche transistors</b>	28		



# NPN transistors up to 25V

Part number	$V_{CE0}$	$I_C$	$I_{CM}$	$P_D$	$h_{FE}$			$V_{CE(sat)}$			$f_T$	$R_{CE(sat)}$	Package
	V	A	A	W	Min.	Max.	@ $I_C$ A	Max. mV	@ $I_C$ A	@ $I_B$ mA			
FZT1047A	10	5	20	2.5	300 200	1200 -	1 5	40 350	0.5 5	10 25	150	44	SOT223 (T1)
FCX1047A	10	4	20	1	300 200	1200 -	1 4	40 240	0.5 4	10 50	150	40	SOT89 (T1)
ZXTN25012EZ	12	6.5	15	2.4	500 185	1500 -	0.01 6.5	60 130	1 2	10 20	260	25	SOT89 (T1)
ZXTN25012EFH	12	6	15	1.25	500 300	1500 -	0.01 4	32 190	1 6	100 120	260	23	SOT23 (T1)
ZXTN07012EFF	12	4.5	10	1.5	500 330	1500 -	0.1 4.5	85 150	1 2	10 20	220	43	SOT23F (T1)
FZT688B	12	4	10	2	500 400	- -	0.1 3	40 400	0.1 4	1 50	150	83	SOT223 (T1)
FCX688B	12	3	10	1	500 400	- -	0.1 3	40 350	0.1 3	1 10	150	-	SOT89 (T1)
ZTX688B	12	3	10	1	500 400	- -	0.1 3	40 350	0.1 3	1 20	150	-	E-Line (T1)
ZXTN25012EFL	12	2	15	0.350	500 210	1500 -	0.01 5	85 130	1 2	10 40	280	46	SOT23 (T1)
ZXTN23015CFH	15	6	12	1.25	200 150	560 -	0.5 6	30 180	1 6	100 120	235	19	SOT23 (T1)
ZXT13N15DE6	15	5	15	1.1	300 200	900 -	1 5	70 200	1 5	10 100	72	29	SOT23-6 (T1)
ZXTN25015DFH	15	5	15	1.25	300 150	900 -	0.01 5	40 215	1 5	100 100	240	25	SOT23 (T1)
ZXTAM322	15	4.5	15	1.5	300 150	- -	0.2 5	14 280	0.1 4.5	10 50	120	45	DFN322 (T1)
ZXT10N15DE6	15	4	13	1.1	300 200	- -	0.2 3	14 260	0.1 4	10 50	120	50	SOT23-6 (T1)
FCX617	15	3	12	1	300 200	- -	0.2 3	14 300	0.1 4	10 50	120	50	SOT89 (T1)
FMMT617	15	3	12	0.625	300 200	- -	0.2 3	14 200	0.1 3	10 50	120	50	SOT23 (T1)
ZXT11N15DF	15	3	5	0.625	300 200	900 -	0.2 3	80 150	1 3	10 150	145	37	SOT23 (T1)
ZUMT617	15	1.5	5	0.385	300 200	- -	0.1 1	20 245	0.1 1.5	10 20	180	135	SOT323 (T1)
FZT1048A	17.5	5	20	2.5	300 180	1200 -	1 5	45 350	0.5 5	10 25	150	50	SOT223 (T1)
ZTX1048A	17.5	4	20	1	300 220	1200 -	1 4	45 245	0.5 4	10 20	150	-	E-Line (T1)
ZXTN19020CFF	20	7.0	20	1.5	200	500 -	0.1 7.0	65 70	1 2	10 40	150	18	SOT23F (T1)
ZXTN19020DG	20	9	20	3	300 130	900 -	0.1 9	70 100	1 2	10 20	160	20	SOT223 (T1)

# NPN transistors up to 25V

Part number	V <sub>CEO</sub> V	I <sub>C</sub> A	I <sub>CM</sub> A	P <sub>D</sub> W	h <sub>FE</sub>			V <sub>CE(sat)</sub>			f <sub>T</sub> MHz	R <sub>CE(sat)</sub> mΩ	Package
					Min.	Max.	@ I <sub>C</sub> A	Max. mV	@ I <sub>C</sub> A	@ I <sub>B</sub> mA			
ZXTN19020DZ	20	7.5	20	2.4	300 150	900 -	0.1 7.5	70 100	1 2	10 20	160	21	SOT89 (T1)
ZXTN25020DG	20	7	15	3	300 50	900 -	0.01 7	48 180	1 2	100 20	215	31	SOT223 (T1)
ZXTN19020DFF	20	6.5	20	1.5	300 160	900 -	0.1 6.5	65 95	1 2	10 20	160	18	SOT23F (T1)
ZXTN25020DZ	20	6	15	2.4	300 50	900 -	0.01 6	48 180	1 2	100 20	215	30	SOT89 (T1)
ZXT13N20DE6	20	4.5	15	1.1	300 200	900 -	1 5	75 230	1 4.5	10 45	96	38	SOT23-6 (T1)
ZXTN25020DFH	20	4.5	15	1.25	300 120	900 -	0.01 4.5	43 265	1 4.5	100 90	215	28	SOT23 (T1)
ZXTBM322	20	4.5	12	1.5	300 100	- -	0.2 6	15 270	0.1 4.5	10 125	140	47	DFN322 (T1)
ZXTN25020BFH	20	4.5	10	1.25	100 75	300 -	0.01 4.5	45 240	1 4.5	100 90	185	27	SOT23 (T1)
ZXTN25020CFH	20	4.5	10	1.25	200 90	500 -	0.01 4.5	45 220	1 4.5	100 90	185	28	SOT23 (T1)
ZXT10N20DE6	20	3.5	19	1.1	300 200	- -	0.2 2	15 250	0.1 3.5	10 100	140	55	SOT23-6 (T1)
ZTX618	20	3.5	10	1	300 170	- -	0.2 3	15 255	0.1 3.5	10 50	140	-	E-Line (T1)
FZT689B	20	3	8	2	500 400	- -	0.1 2	100 450	0.1 3	0.5 20	150	92	SOT223 (T1)
ZTX689B	20	3	8	1	500 400	- -	0.1 2	100 500	0.1 2	0.5 10	150	-	E-Line (T1)
ZXT11N20DF	20	2.5	5	0.625	300 150	900 -	0.1 3	100 130	1 2.5	10 250	160	40	SOT23 (T1)
FMMT618	20	2.5	6	0.625	300 200	- -	0.2 2	15 200	0.1 2.5	10 50	140	50	SOT23 (T1)
ZXTN25020DFL	20	2	8	0.350	300 220	900 -	0.01 2	100 225	1 2	20 20	215	55	SOT23 (T1)
FMMTL618	20	1.25	4	0.5	300 200	- -	0.2 1	35 280	0.1 1.25	10 100	195	140	SOT23 (T1)
ZUMT618	20	1.25	4	0.385	300 100	- -	0.1 1	25 250	0.1 1.25	10 50	210	125	SOT323 (T1)

continued overleaf...

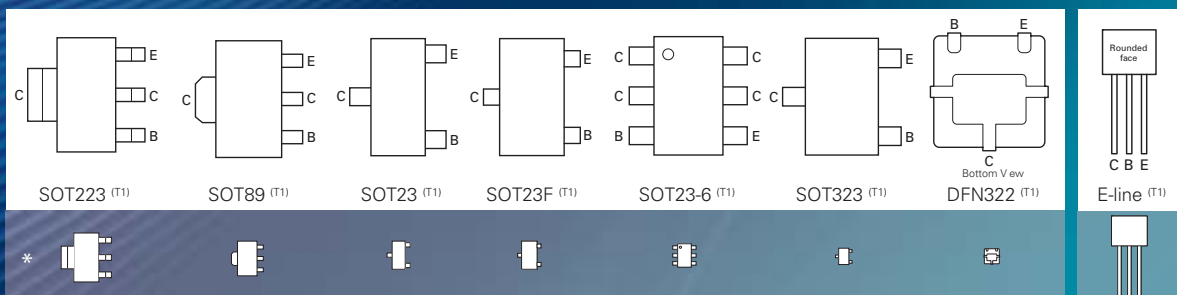

\*Indicative relative size

## NPN transistors up to 25V (continued)

Part number	V <sub>CEO</sub> V	I <sub>C</sub> A	I <sub>CM</sub> A	P <sub>D</sub> W	h <sub>FE</sub>			V <sub>CE(sat)</sub>			f <sub>T</sub> MHz	R <sub>CE(sat)</sub> mΩ	Package
					Min.	Max.	@ I <sub>C</sub> A	Max. mV	@ I <sub>C</sub> A	@ I <sub>B</sub> mA			
BCX6825	20	1	2	1	160	400	0.5	500	1	100	100	-	SOT89 <sup>(T1)</sup>
FZT869	25	7	20	3	300 200	- -	1 7	50 350	0.5 6.5	10 150	100	36	SOT223 <sup>(T1)</sup>
ZXTN2005G	25	7	20	3	300 200	- -	1 7	40 230	0.5 6.5	10 150	150	30	SOT223 <sup>(T1)</sup>
ZXTN2005Z	25	5.5	20	2.1	300 200	- -	1 7	45 200	1 6.5	100 150	150	25	SOT89 <sup>(T1)</sup>
FZT1049A	25	5	20	2.5	300 180	1200 -	1 5	60 330	0.5 5	10 50	180	-	SOT223 <sup>(T1)</sup>
ZTX869	25	5	20	1.2	300 250	- -	1 5	50 220	0.5 5	10 100	100	-	E-Line <sup>(T1)</sup>
ZTX1049A	25	4	20	1	300 200	1200 -	1 4	45 220	0.5 4	10 50	180	-	E-Line <sup>(T1)</sup>
FZT649	25	3	8	2	100 75	300 -	1 2	300 600	1 3	100 300	240	-	SOT223 <sup>(T1)</sup>
ZTX649	25	2	6	1	100 75	300 -	1 2	300 500	1 2	100 200	240	-	E-Line <sup>(T1)</sup>

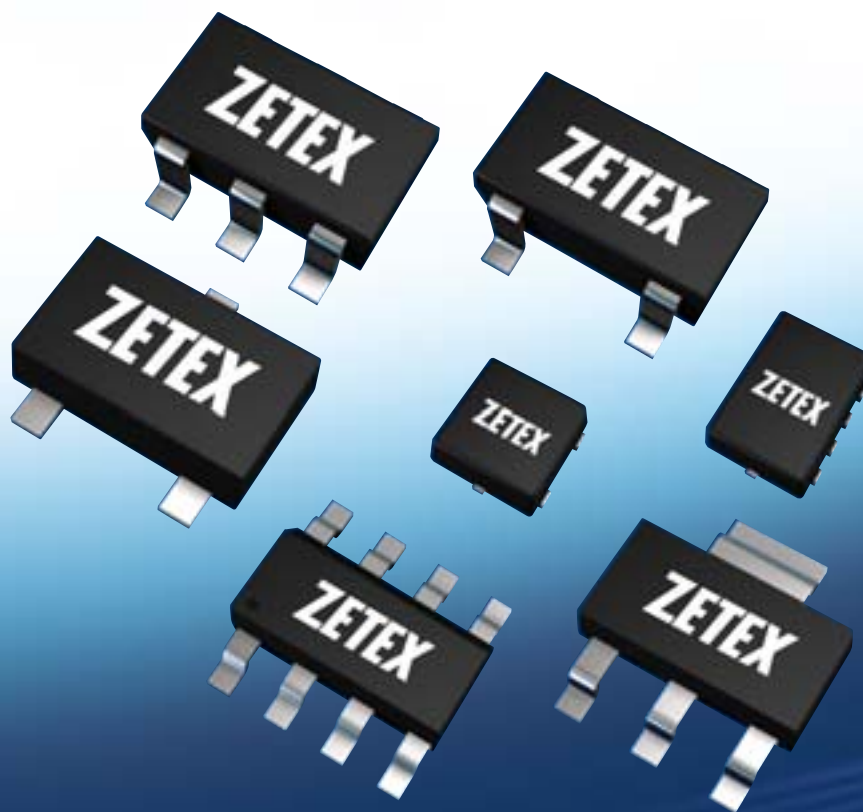

# PNP transistors up to 25V



Part number	V <sub>CEO</sub> V	I <sub>C</sub> A	I <sub>CM</sub> A	P <sub>D</sub> W	h <sub>FE</sub>			V <sub>CE(sat)</sub>			f <sub>T</sub> MHz	R <sub>CE(sat)</sub> mΩ	Package
					Min.	Max.	@ I <sub>C</sub> A	Max. mV	@ I <sub>C</sub> A	@ I <sub>B</sub> mA			
FZT968	-12	-6	-20	3	300 200	1000 -	-0.5 -5	-130 -450	-0.5 -6	-5 -250	80	44	SOT223 (T1)
FZT1147A	-12	-5	-20	2.5	250 150	850 -	-0.5 -5	-110 -400	-0.5 -5	-2.5 -50	115	-	SOT223 (T1)
ZTX968	-12	-4.5	-20	1.2	300 200	1000 -	-0.5 -5	-100 -300	-0.5 -5	-5 -200	80	-	E-Line (T1)
ZXTP25012EZ	-12	-4.5	-10	2.4	500 40	1500 -	-0.01 -4.5	-265 -355	-1 -2	-10 -40	310	45	SOT89 (T1)
ZTX1147A	-12	-4	-20	1	250 170	850 -	-0.5 -4	-130 -235	-1 -4	-6 -70	115	-	E-Line (T1)
ZXT13P12DE6	-12	-4	-15	1.1	300 200	900 -	-1 -4	-90 -250	-1 -4	-10 -50	55	37	SOT23-6 (T1)
ZXT1M322	-12	-4	-12	1.5	300 60	-	-0.1 -8	-17 -300	-0.1 -4	-10 -150	110	60	DFN322 (T1)
ZXTP25012EFH	-12	-4	-10	1.25	500 300	1500 -	-0.01 -1	-260 -350	-1 -2	-10 -40	310	40	SOT23 (T1)
ZXTP07012EFF	-12	-4	-8	1.5	500 230	1500 -	-0.01 -4	-165 -350	-1 -2	-5 -10	250	50	SOT23F (T1)
FCX1147A	-12	-3	-20	1	250 200	850 -	-0.5 -3	-110 -250	-0.5 -3	-2.5 -30	115	53	SOT89 (T1)
FCX717	-12	-3	-10	1	300 160	-	-0.1 -3	-20 -320	-0.1 -3	-10 -50	110	77	SOT89 (T1)
FZT717	-12	-3	-10	2	300 160	-	-0.1 -3	-17 -320	-0.1 -3	-10 -50	110	-	SOT223 (T1)
ZXT10P12DE6	-12	-3	-10	1.1	300 180	-	-0.1 -2.5	-17 -300	-0.1 -3	-10 -50	110	65	SOT23-6 (T1)
FMMT717	-12	-2.5	-10	0.625	300 180	-	-0.1 -2.5	17 -220	-0.1 -2.5	-10 -50	110	72	SOT23 (T1)
FMMTL717	-12	-1.25	-4	0.5	300 180	-	-0.1 -1	-40 -290	-0.1 -1.25	-10 -50	205	160	SOT23 (T1)
ZUMT717	-12	-1.25	-3	0.385	300 125	-	-0.1 -1.25	-40 -240	-0.1 -1.25	-10 -100	220	150	SOT323 (T1)
ZXTP23015CFH	-15	-6	-10	1.25	200 140	560 -	-0.5 -6	-36 -190	-1 -6	-100 -240	270	20	SOT23 (T1)
ZXTP25015DFH	-15	-4	-10	1.25	300 90	900 -	-0.01 -4	-55 -210	-1 -4	-100 -200	295	33	SOT23 (T1)

continued overleaf...

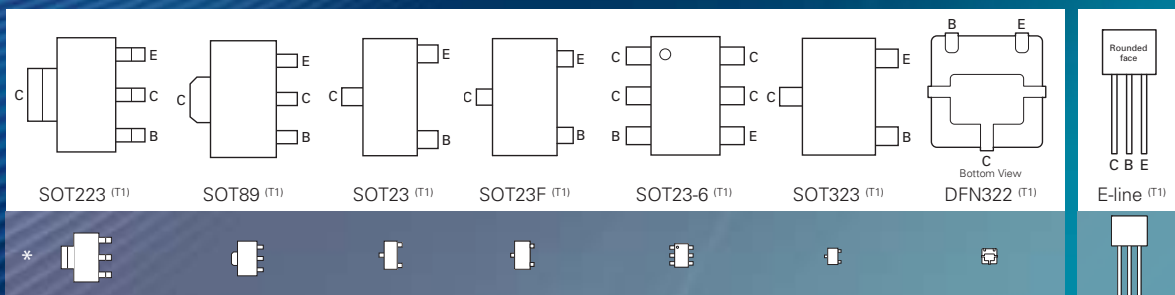

\*Indicative relative size

# PNP transistors up to 25V (continued)

Part number	V <sub>CEO</sub>	I <sub>C</sub>	I <sub>CM</sub>	P <sub>D</sub>	h <sub>FE</sub>			V <sub>CE(sat)</sub>			f <sub>T</sub>	R <sub>CE(sat)</sub>	Package
	V	A	A	W	Min.	Max.	@ I <sub>C</sub> A	Max. mV	@ I <sub>C</sub> A	@ I <sub>B</sub> mA	MHz	mΩ	
ZTX788A	-15	-3	-10	1	300 200	800 -	-0.01 2	-35 -330	-0.1 -3	-2 -200	150	-	E-Line <sup>(T1)</sup>
FZT788B	-15	-3	-8	2	400 300	-	-1 -2	-150 -500	-0.5 -3	-2.5 -50	100	93	SOT223 <sup>(T1)</sup>
ZTX788B	-15	-3	-8	1	400 300	-	-1 -2	-150 -450	-0.5 -2	-2.5 -10	100	-	E-Line <sup>(T1)</sup>
ZXTP19020DG	-20	-8	-15	3	300 45	900 -	-0.1 -8	-130 -145	-1 -2	-10 -40	176	28	SOT223 <sup>(T1)</sup>
FZT948	-20	-6	-20	3	100 75	300	-1 -5	-130 -450	-0.5 -6	-10 -250	80	-	SOT223 <sup>(T1)</sup>
ZXTP19020DZ	-20	-6	-15	2.4	300 65	900 -	-0.1 -6	-130 -145	-1 -2	-10 -40	176	28	SOT89 <sup>(T1)</sup>
ZXTP25020DG	-20	-6	-10	3	300 25	900 -	-0.01 -6	-65 -245	-1 -2	-100 -40	290	42	SOT223 <sup>(T1)</sup>
ZXTP19020DFF	-20	-5.5	-15	1.5	300 90	900 -	-0.1 -5	-125 -140	-1 -2	-10 -40	176	26	SOT23F <sup>(T1)</sup>
ZXTP19020CFF	-20	-5	-15	1.5	200 110	500 -	-0.1 -5	-70 -120	-1 -2	-20 -40	200	21	SOT23F <sup>(T1)</sup>
ZXTP25020DZ	-20	-5	-10	2.4	300 45	900 -	-0.01 -5	-65 -245	-1 -2	-100 -40	290	39	SOT89 <sup>(T1)</sup>
ZTX948	-20	-4.5	-20	1.2	100 75	300	-1 -5	-100 -250	-0.5 -4	-10 -400	80	-	E-Line <sup>(T1)</sup>
ZXTP25020CFF	-20	-4.5	-10	1.5	200 150	500 -	-0.01 -1	-110 -185	-1 -2	-20 -40	285	41	SOT23F <sup>(T1)</sup>
ZXTP25020BFH	-20	-4	-10	1.25	100 50	300 -	-0.01 -4	-60 -210	-1 -4	-100 -200	250	32	SOT23 <sup>(T1)</sup>
ZXTP25020CFH	-20	-4	-10	1.25	200 85	500 -	-0.01 -4	-55 -210	-1 -4	-100 -200	285	34	SOT23 <sup>(T1)</sup>
ZXTP25020DFH	-20	-4	-10	1.25	300 70	900 -	-0.01 -4	-60 -240	-1 -2	-100 -40	290	39	SOT23 <sup>(T1)</sup>
ZX5T2E6	-20	-3.5	-10	1.1	300 150	900	-1 -3.5	-140 -130	-1 -3.5	-10 -350	110	31	SOT23-6 <sup>(T1)</sup>
ZXT13P20DE6	-20	-3.5	-10	1.1	300 150	900	-1 -3.5	-130 -250	-1 -3.5	-10 -350	90	47	SOT23-6 <sup>(T1)</sup>
ZXTP2006E6	-20	-3.5	-10 150	1.1	300 -3.5	900 -130	-1 -3.5	-140 -350	-1	-10	110	31	SOT23-6 <sup>(T1)</sup>
ZXT2M322	-20	-3.5	-6	1.5	300 150	-	-0.1 -2	-30 -300	-0.1 -3.5	-10 -350	180	64	DFN322 <sup>(T1)</sup>
FCX718	-20	-2.5	-6	1	300 150	-	-0.1 -2	-40 -300	-0.1 -2.5	-10 -200	180	96	SOT89 <sup>(T1)</sup>
ZTX718	-20	-2.5	-6	1	300 150	-	-0.1 -2	-40 -260	-0.1 -2.5	-10 -200	180	-	E-Line <sup>(T1)</sup>

# PNP transistors up to 25V

Part number	V <sub>CEO</sub> V	I <sub>C</sub> A	I <sub>CM</sub> A	P <sub>D</sub> W	h <sub>FE</sub>			V <sub>CE(sat)</sub>			f <sub>T</sub> MHz	R <sub>CE(sat)</sub> mΩ	Package
					Min.	Max.	@ I <sub>C</sub> A	Max. mV	@ I <sub>C</sub> A	@ I <sub>B</sub> mA			
ZXT10P20DE6	-20	-2.5	-6	1.1	300 150	-	-0.1 -2	-30 -350	-0.1 -2.5	-10 -150	180	75	SOT23-6 (T1)
FMMT718	-20	-1.5	-6	0.625	300 150	-	-0.1 -2	-40 -220	-0.1 -1.5	-10 -50	180	97	SOT23 (T1)
ZXTP25020DFL	-20	-1.5	-6	0.350	300 60	900 -	-0.01 -4	-225 -275	-1 -2	-10 -40	290	54	SOT23 (T1)
ZUMT718	-20	-1	-3	0.385	300 100	-	-0.1 -1	-45 -250	-0.1 -1	-10 -100	210 -	200	SOT323 (T1)
BCX6925	-20	-1	-2	1	160	400	-0.5	-500	-1	-100	100	-	SOT89 (T1)
FMMTL718	-20	-1	-2	0.5	300 120	-	-0.1 -1	-50 -320	-0.1 -1	-10 -50	265 -	210	SOT23 (T1)
FZT1149A	-25	-4	-10	2.5	250 115	800 -	-0.5 -5	-240 -350	-1 -4	-7 -140	135 -	-	SOT223 (T1)
FCX1149A	-25	-3	-10	1	250 150	800 -	-0.5 -3	-240 -300	-1 -3	-7 -100	135 -	67	SOT89 (T1)
ZTX1149A	-25	-3	-10	1	250 115	800 -	-0.5 -5	-170 -300	-0.5 -3	-3 -70	135 -	-	E-Line (T1)
FCX789A	-25	-3	-8	1	230 180	-	-1 -2	-190 -320	-1 -3	-10 -100	100 -	-	SOT89 (T1)
FZT749	-25	-3	-8	2	100 75	300 -	-1 -2	-300 -600	-1 -3	-100 -300	160 -	-	SOT223 (T1)
ZTX789A	-25	-3	-8	1	250 200	-	-1 -2	-250 -500	-1 -3	-10 -100	100 -	-	E-Line (T1)
FZT789A	-25	-3	-6	2	250 200	-	-1 -2	-250 -500	-1 -3	-10 -100	100 -	93	SOT223 (T1)
ZTX749	-25	-2	-6	1	100 75	300 -	-1 -2	-300 -500	-1 -2	-100 -200	160 -	-	E-Line (T1)

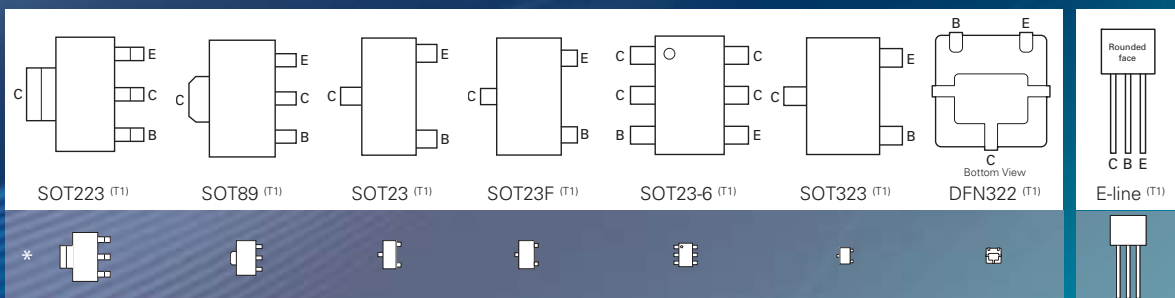

\*Indicative relative size

# NPN transistors from 30 to 50V

Part number	V <sub>CEO</sub>	I <sub>C</sub>	P <sub>D</sub>	h <sub>FE</sub>			V <sub>CE(sat)</sub>			f <sub>T</sub>	R <sub>CE(sat)</sub>	Package
	V	A	W	Min.	Max.	@ I <sub>C</sub> A	Max. mV	@ I <sub>C</sub> A	@ I <sub>B</sub> mA	MHz	mΩ	
ZXT849K	30	7	4.2	100 100	300 -	1 7	80 280	1 7	20 350	100	33	DPAK (T1)
FZT849	30	7	3	100 100	300 -	1 7	110 350	1 6.5	20 300	100	36	SOT223 (T1)
ZXTN2007G	30	7	3	100 100	300 -	1 7	65 220	1 6.5	20 300	140	28	SOT223 (T1)
ZXTN2007Z	30	6	2.1	100 100	300 -	1 7	45 190	1 6.5	100 300	140	23	SOT89 (T1)
ZTX849	30	5	1.2	100 100	300 -	1 5	100 220	1 5	20 200	100	-	E-Line (T1)
FZT489	30	1	2	100 60	300 -	1 2	300 600	1 2	100 200	150	-	SOT223 (T1)
ZTX449	30	1	1	100 80	300 -	0.5 1	500 1000	1 2	100 200	150	-	E-Line (T1)
FMMT449	30	1	0.5	100 80	300 -	0.5 1	500 1000	1 2	100 200	150	250	SOT23 (T1)
FMMT489	30	1	0.5	100 60	300 -	1 2	300 600	1 2	100 200	150	175	SOT23 (T1)
FZT1051A	40	5	2.5	270 130	1200 -	1 5	120 340	1 5	10 100	155	50	SOT223 (T1)
ZXTN25040DZ	40	5	1.8	300 20	900 -	0.01 5	60 215	1 2	100 40	190	38	SOT89 (T1)
ZXTN25040DFH	40	4	1.25	300 30	900 -	0.01 4	55 190	1 4	100 400	190	35	SOT23 (T1)
ZTX1051A	40	4	1	300 190	1200 -	1 4	110 210	1 4	10 100	155	-	E-Line (T1)
FCX1051A	40	3	1	270 270	1200 -	1 3	120 250	1 3	10 40	155	57	SOT89 (T1)
ZXTN25040DFL	40	1.5	0.350	300 25	900 -	0.01 4	85 185	1 1.5	100 30	190	59	SOT23 (T1)
FZT491A	40	1	2	300 200	900 -	0.5 1	300 500	0.5 1	50 100	150	-	SOT223 (T1)
FCX491A	40	1	1	300 200	900 -	0.5 1	300 500	0.5 1	50 100	150	-	SOT89 (T1)
FMMT491A	40	1	0.5	300 200	900 -	0.5 1	300 500	0.5 1	50 100	150	195	SOT23 (T1)
ZXTN2040F	40	1	0.35	300 200	900 -	0.5 1	300 500	0.5 1	50 100	150	-	SOT23 (T1)
ZXTN07045EFF	45	6	1.5	500 250	1500 -	0.1 2	190 220	1 2	15 20	190	50	SOT23F (T1)
ZXT690BK	45	3	3.9	400 150	- -	1 2	85 360	0.1 1	0.5 5	150	77	DPAK (T1)
FZT690B	45	3	2	400 50	- -	1 3	100 500	0.1 1	0.5 5	150	125	SOT223 (T1)
FCX690B	45	2	1	400 150	- -	1 2	80 300	0.1 1	0.5 5	150	-	SOT89 (T1)



# NPN transistors from 30 to 50V

Part number	V <sub>CEO</sub>	I <sub>C</sub>	P <sub>D</sub>	h <sub>FE</sub>			V <sub>CE(sat)</sub>			f <sub>T</sub>	R <sub>CE(sat)</sub>	Package
	V	A	W	Min.	Max.	@ I <sub>C</sub> A	Max. mV	@ I <sub>C</sub> A	@ I <sub>B</sub> mA			
ZTX690B	45	2	1	400 150	- -	1 2	100 500	0.1 1	0.5 5	150	-	E-Line <sup>(T1)</sup>
ZTX450	45	1	1	100 15	300 -	0.15 1	250	0.15	15	150	-	E-Line <sup>(T1)</sup>
BCW66H	45	0.8	0.33	250	630	0.1	300	0.1	10	100	-	SOT23 <sup>(T1)</sup>
ZXTN2031F	50	5	1.2	200 80	560	0.5 5	40 170	1 5	100 250	125	24	SOT23 <sup>(T1)</sup>
ZXTCM322	50	4	1.5	300 100	- -	0.2 2	20 320	0.1 4	10 200	165	68	DFN322 <sup>(T1)</sup>
ZXTN25050DFH	50	4	1.25	300 20	900 -	0.01 4	60 210	1 4	100 400	200	40	SOT23 <sup>(T1)</sup>
ZXT13N50DE6	50	4	1.1	300 100	900 -	1 4	100 230	1 4	10 100	115	36	SOT23-6 <sup>(T1)</sup>
FCX619	50	3	1.5	300 100	- -	0.2 2	25 320	0.1 2.75	10 100	165	87	SOT89 <sup>(T1)</sup>
ZXT10N50DE6	50	3	1.1	300 100	- -	0.2 2	20 200	0.1 2	10 50	170	75	SOT23-6 <sup>(T1)</sup>
FMMT619	50	2	0.625	300 100	- -	0.2 2	20 220	0.1 2	10 50	165	75	SOT23 <sup>(T1)</sup>
FMMTL619	50	1.25	0.5	300 100	- -	0.2 1	45 330	0.1 1.25	10 125	180	160	SOT23 <sup>(T1)</sup>
ZUMT619	50	1	0.385	300 75	- -	0.1 1	35 270	0.1 1	10 50	215	160	SOT323 <sup>(T1)</sup>

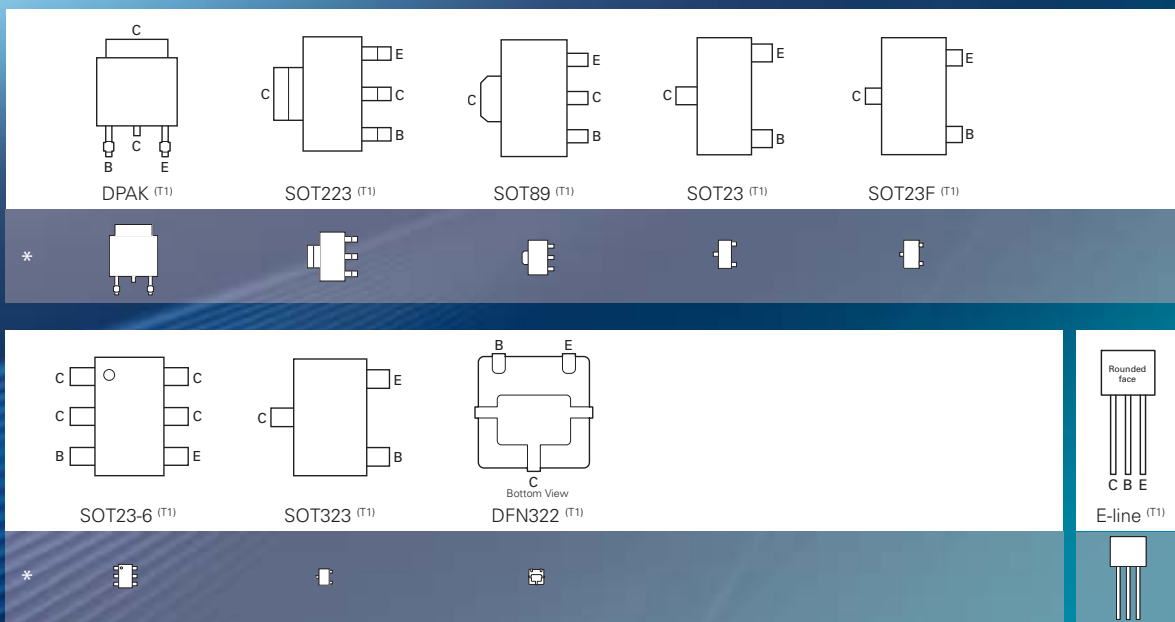

\*Indicative relative size

# PNP transistors from 30 to 50V



Part number	$V_{CE0}$	$I_C$	$P_D$	$h_{FE}$			$V_{CE(sat)}$			$f_T$	$R_{CE(sat)}$	Package
	V	A	W	Min.	Max.	@ $I_C$ A	Max. mV	@ $I_C$ A	@ $I_B$ mA	MHz	m $\Omega$	
FZT949	-30	-5.5	3	100 75	300 -	-1 -5	-75 -440	-0.5 -5.5	-20 -500	100	-	SOT223 (T1)
ZX5T949G	-30	-5.5	3	100 70	300 -	-1 -5	-45 -210	-0.5 -5.5	-20 -500	110	31	SOT223 (T1)
ZXTP2008G	-30	-5.5	3	100 70	300 -	-1 -5	-45 -210	-0.5 -5.5	-20 -500	110	31	SOT223 (T1)
ZXTP2008Z	-30	-5.5	2.1	100 70	300 -	-1 -5	-55 -175	-1 -5.5	-100 -500	110	24	SOT89 (T1)
ZTX949	-30	-4.5	1.2	100 75	300 -	-1 -5	-60 -320	-0.5 -5	-20 -300	100	-	E-Line (T1)
FZT549	-30	-1	2	100 80	300 -	-0.5 -1	-500 -750	-1 -2	-100 -200	100	-	SOT223 (T1)
FZT589	-30	-1	2	100 40	300 -	-0.5 -2	-350 -650	-1 -2	-100 -200	100	-	SOT223 (T1)
FCX589	-30	-1	1	100 80	300 -	-0.5 -1	-350 -650	-1 -2	-100 -200	100	-	SOT89 (T1)
ZTX549	-30	-1	1	100 80	300 -	-0.5 -1	-500 -750	-1 -2	-100 -200	100	-	E-Line (T1)
FMMT549	-30	-1	0.5	100 40	300 -	-0.5 -2	-500 -750	-1 -2	-100 -200	100	250	SOT23 (T1)
FMMT549A	-30	-1	0.5	150 40	500 -	-0.5 -2	-300 -750	-0.1 -2	-1 -200	100	250	SOT23 (T1)
FMMT589	-30	-1	0.5	100 80	300 -	-0.5 -1	-350 -650	-1 -2	-100 -200	100	250	SOT23 (T1)
ZXTP2009Z	-40	-5.5	2.1	200	550	-0.5	-165 -175	-1 -3.5	-10 -175	152	29	SOT89 (T1)
ZX5T3Z	-40	-5.5	1.5	200 110	550 -	-0.5 5.5	-70 -185	-1 -5.5	-50 -550	152	29	SOT89 (T1)
ZXTP25040DZ	-40	-3.5	2.4	300 20	900 -	-0.01 -3.5	-90 -265	-1 -1	-100 -20	270	55	SOT89 (T1)
ZXTP07040DFF	-40	-3	1.5	300 200	800 -	-0.01 -1	-180 -540	-0.5 -2	-5 -40	200	67	SOT23F (T1)
ZXT790AK	-40	-3	3.9	250 150	- -	-0.5 -2	-170 -350	-0.5 -1	-5 -10	100	83	DPAK (T1)
FZT1151A	-40	-3	2.5	250 100	800 -	-0.5 -3	-180 -300	-0.5 -3	-5 -250	145	-	SOT223 (T1)
FZT790A	-40	-3	2	250 150	- -	-0.5 -2	-250 -750	-0.5 -2	-5 -50	100	125	SOT223 (T1)
ZXT3M322	-40	-3	1.5	300 60	- -	-0.1 -1.5	-40 -370	-0.1 -2.5	-10 -250	190	104	DFN322 (T1)
ZXTP25040DFH	-40	-3	1.25	300 30	900 -	-0.01 -3	-85 -220	-1 -3	-100 -300	270	55	SOT23 (T1)
ZXT13P40DE6	-40	-3	1.1	300 100	900 -	-1 -3	-200 -240	-1 -3	-20 -300	115	58	SOT23-6 (T1)
FCX1151A	-40	-3	1	250 100	800 -	-0.5 -3	-180 -300	-0.5 -3	-5 -350	145	66	SOT89 (T1)

# PNP transistors from 30 to 50V

Part number	V <sub>CEO</sub> V	I <sub>C</sub> A	P <sub>D</sub> W	h <sub>FE</sub>			V <sub>CE(sat)</sub>			f <sub>T</sub> MHz	R <sub>CE(sat)</sub> mΩ	Package
				Min.	Max.	@ I <sub>C</sub> A	Max. mV	@ I <sub>C</sub> A	@ I <sub>B</sub> mA			
ZXT10P40DE6	-40	-2	1.1	300 60	- -	-0.1 -1.5	-40 -300	-0.1 -2	-10 -200	190	105	SOT23-6 (T1)
FCX790A	-40	-2	1	250 150	- -	-0.5 -2	-250 -450	-0.5 -2	-5 -50	100	-	SOT89 (T1)
ZTX790A	-40	-2	1	300 150	800 -	-0.01 -2	-250 -750	-0.5 -2	-5 -50	100	-	E-Line (T1)
ZXTP25040DFL	-40	-1.5	0.350	300 15	900 -	-0.01 -3	-95 -190	-0.5 -1.5	-20 -75	270	82	SOT23 (T1)
FMMT720	-40	-1.5	0.625	300 60	- -	-0.1 -1.5	-40 -330	-0.1 -1.5	-10 -100	190	163	SOT23 (T1)
FZT591A	-40	-1	2	300 160	800 -	-0.1 -1	-200 -500	-0.1 -1	-1 -100	150	350	SOT223 (T1)
FCX591A	-40	-1	1	300 160	800 -	-0.1 -1	-200 -500	-0.1 -1	-1 -100	150	-	SOT89 (T1)
FMMT591A	-40	-1	0.5	300 160	800 -	-0.1 -1	-200 -500	-0.1 -1	-1 -100	150	350	SOT23 (T1)
ZXTP2041F	-40	-1	0.35	300 160	800 -	-0.1 -1	-200 -500	-0.1 -1	-1 -100	150	350	SOT23 (T1)
ZUMT720	-40	-0.75	0.385	300 40	- -	-0.1 -0.75	-65 -250	-0.1 -0.75	-10 -100	220	240	SOT323 (T1)
ZTX550	-45	-1	1	100 15	300 -	-0.15 -1	-350	-0.15	-15	150	-	E-Line (T1)
BCW68H	-45	-0.8	0.33	250	630	-0.1	-300	-0.1	-10	100	-	SOT23 (T1)
ZXTP2025F	-50	-5	1.2	200 70	560	-0.5 -5	-60 -200	-1 -5	-100 -500	190	30	SOT23 (T1)

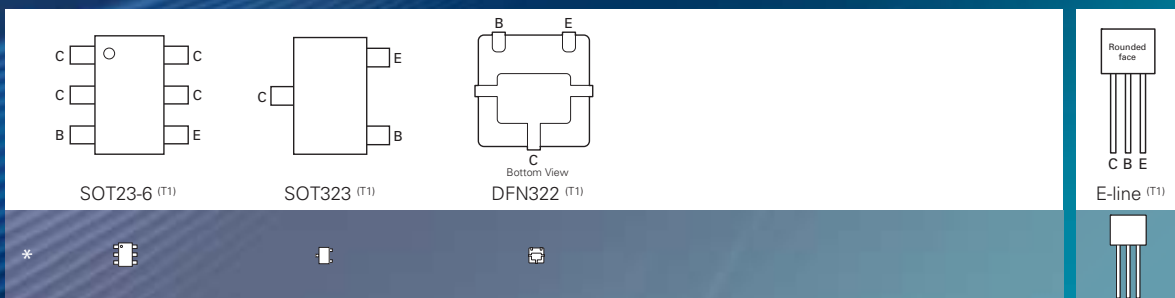
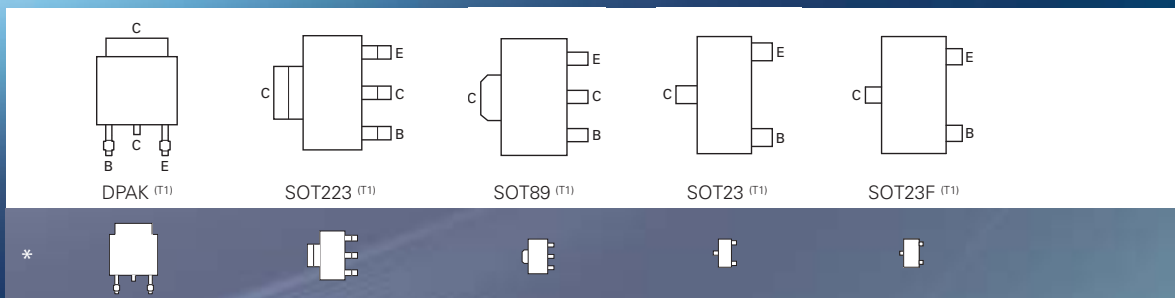

\*Indicative relative size

# NPN transistors from 55 to 100V



Part number	V <sub>CEO</sub>	I <sub>C</sub>	P <sub>D</sub>	h <sub>FE</sub>			V <sub>CE(sat)</sub>			f <sub>T</sub>	R <sub>CE(sat)</sub>	Package
	V	A	W	Min.	Max.	@ I <sub>C</sub> A	Max. mV	@ I <sub>C</sub> A	@ I <sub>B</sub> mA	MHz	mΩ	
ZXTN19055DZ	55	6	2.1	250 30	700 -	0.01 6	60 250	1 6	100 600	200	28	SOT89 (T1)
ZXTN19060CG	60	7	3	200 160	500 -	0.1 2	50 150	1 2	100 40	130	30	SOT223 (T1)
FZT851	60	6	3	100 25	300 -	2 10	100 375	1 6	50 300	130	44	SOT223 (T1)
ZXTN2010G	60	6	3	100 20	300 -	2 10	70 260	1 6	50 300	130	-	SOT223 (T1)
ZX5T851G	60	6	3	100 20	300 -	2 10	70 260	1 6	50 300	130	-	SOT223 (T1)
ZXTN19060CFF	60	5.5	1.5	200 160	500 -	0.1 2	45 135	1 2	100 40	130	26	SOT23F (T1)
ZXTN2010Z	60	5	2.1	100 20	300 -	2 10	55 230	1 6	100 300	130	-	SOT89 (T1)
ZTX851	60	5	1.2	100 25	300 -	2 10	100 250	1 5	50 200	130	-	E-Line (T1)
ZXTN2018F	60	5	1.2	100 40	300 -	2 5	55 170	1 5	50 250	130	25	SOT23 (T1)
ZXTN25060BZ	60	4.5	1.8	100 45	300 -	0.01 2	90 305	1 5	50 500	185	48	SOT89 (T1)
ZXTN2010A	60	4.5	1	100 20	300 -	2 10	65 210	1 5	50 200	130	-	E-Line (T1)
ZX5T851A	60	4.5	1	100 20	300 -	2 10	65 210	1 5	50 200	130	-	E-Line (T1)
ZXTN25060BFH	60	3.5	1.25	100 25	300 -	0.01 3.5	65 175	1 3.5	100 350	185	43	SOT23 (T1)
FZT651	60	3	2	100 40	300 -	0.5 2	600	3	300	140	-	SOT223 (T1)
ZTX651	60	2	1	100 40	300 -	0.5 2	500	2	200	140	-	E-Line (T1)
FZT491	60	1	2	100	300	0.5	500	1	100	150	-	SOT223 (T1)
FCX491	60	1	1	100	300	0.5	500	1	100	150	-	SOT89 (T1)
ZTX451	60	1	1	50	150	0.15	350	0.15	15	150	-	E-Line (T1)
FMMT451	60	1	0.5	50	150	0.15	350	0.15	15	150	400	SOT23 (T1)
FMMT491	60	1	0.5	100 30	300 -	0.5 2	150 250	0.5 1	50 100	150	160	SOT23 (T1)
FMMT493A	60	1	0.5	500	-	0.15	500	1	100	150	-	SOT23 (T1)
ZXTN2038F	60	1	0.35	100 80	300 -	0.5 1	200 250	0.1 0.5	2 50	150	-	SOT23 (T1)
ZUMT491	60	1	0.33	100	300	0.5	500	1	100	150	-	SOT323 (T1)
FZT692B	70	2	2	400 150	- -	0.5 1	500	1	10	150	-	SOT223 (T1)
ZTX692B	70	1	1	400 150	- -	0.5 1	500	1	10	150	-	E-Line (T1)
ZXT1053AK	75	5	4	300 50	1200 -	1 5	160 460	1 5	10 200	140	70	DPAK (T1)
FZT1053A	75	4.5	2.5	300 40	1200 -	0.5 4.5	200 440	1 4.5	10 200	140	78	SOT223 (T1)
FCX1053A	75	3	1	300 40	1200 -	0.5 4.5	200 440	1 4.5	10 200	140	78	SOT89 (T1)
ZTX1053A	75	3	1	300 100	1200 -	1 3	150 250	1 3	10 100	140	-	E-Line (T1)

# NPN transistors from 55 to 100V

Part number	V <sub>CEO</sub>	I <sub>C</sub>	P <sub>D</sub>	h <sub>FE</sub>			V <sub>CE(sat)</sub>			f <sub>T</sub>	R <sub>CE(sat)</sub>	Package
	V	A	W	Min.	Max.	@ I <sub>C</sub> A	Max. mV	@ I <sub>C</sub> A	@ I <sub>B</sub> mA			
ZXTEM322	80	3.5	1.5	300 110	900 -	0.2 1	20 185	0.1 1	10 20	160	68	DFN322 (T1)
FMMT620	80	1.5	0.625	300 100	900 -	0.2 1	20 185	0.1 1	10 20	160	90	SOT23 (T1)
BCX5616	80	1	1	100	250	0.15	500	0.5	50	150	-	SOT89 (T1)
BSR43	80	1	1	100	300	0.1	250	0.15	15	100	-	SOT89 (T1)
FMMTA06	80	0.5	0.33	50	-	0.1	250	0.1	10	100	-	SOT23 (T1)
FZT853	100	6	3	100 25	300 -	2 10	150 340	2 5	100 500	130	44	SOT223 (T1)
ZXTN2011G	100	6	3	100 10	300 -	2 10	65 220	1 5	100 500	130	-	SOT223 (T1)
ZX5T853G	100	6	3	100 10	300 -	2 10	65 220	1 5	100 500	130	-	SOT223 (T1)
ZXTN19100CG	100	5.5	3	200 130	500 -	0.1 1	65 140	1 1	100 20	150	43	SOT223 (T1)
ZXTN19100CZ	100	5.25	2.4	200 130	500 -	0.1 1	65 140	1 1	100 20	150	44	SOT89 (T1)
ZXTN19100CFF	100	4.5	1.5	200 130	500 -	0.1 1	135 235	1 4.5	20 450	150	38	SOT23F (T1)
ZXTN2011Z	100	4.5	2.1	100 10	300 -	2 10	60 195	1 5	100 500	130	-	SOT89 (T1)
ZX5T853Z	100	4.5	2.1	100 10	300 -	2 10	60 195	1 5	100 500	130	-	SOT89 (T1)
ZTX853	100	4	1.2	100 20	300 -	2 10	85 200	2 4	100 400	130	-	E-Line (T1)
ZXTN2020F	100	4	1.2	100 35	300 -	1 4	50 150	1 4	100 400	130	-	SOT23 (T1)
ZXTN25100DG	100	3	3	300 40	900 -	0.01 1	170 100	0.5 1	10 100	175	85	SOT223 (T1)
ZXTN25100BFH	100	3	1.25	100 50	300 -	0.01 1	80 250	1 3	100 300	160	67	SOT23 (T1)
ZXTN25100DFH	100	2.5	1.25	300 40	900 -	0.01 1	95 330	1 2.5	100 250	175	86	SOT23 (T1)
ZXTN25100DZ	100	2.5	2.4	300 40	900 -	0.01 1	170 100	0.5 1	10 100	175	80	SOT89 (T1)
FZT653	100	2	2	100 25	300 -	0.5 2	300 500	1 2	100 200	175	-	SOT223 (T1)
ZTX653	100	2	1	100 25	300 -	0.5 2	300 500	1 2	100 200	175	-	E-Line (T1)
FZT493	100	1	2	100	300	0.25	300	0.5	50	150	-	SOT223 (T1)
FCX493	100	1	1	100	300	0.25	300	0.5	50	150	-	SOT89 (T1)
ZTX453	100	1	1	40	200	0.15	700	0.15	15	150	-	E-Line (T1)
FMMT493	100	1	0.5	100	300	0.25	300	0.5	50	150	-	SOT23 (T1)

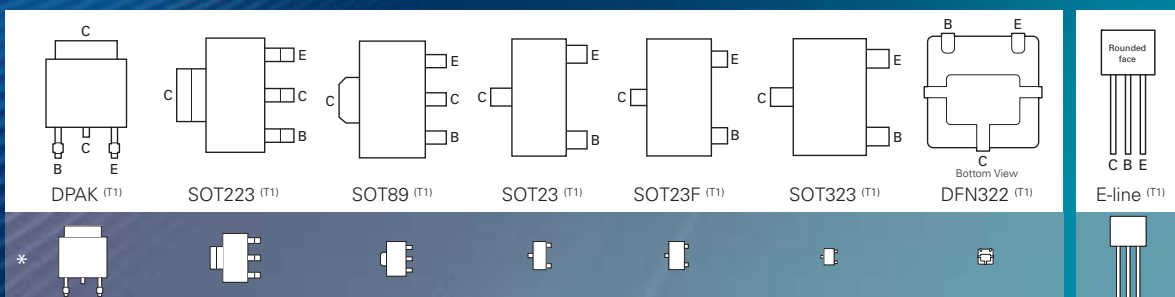

\*Indicative relative size

# PNP transistors from 60 to 100V



Part number	V <sub>CEO</sub>	I <sub>C</sub>	P <sub>D</sub>	h <sub>FE</sub>			V <sub>CE(sat)</sub>			f <sub>T</sub>	R <sub>CE(sat)</sub>	Package
	V	A	W	Min.	Max.	@ I <sub>C</sub> A	Max. mV	@ I <sub>C</sub> A	@ I <sub>B</sub> mA	MHz	mΩ	
ZXT951K	-60	-6	4.2	100 15	300 -	-2 -10	-90 -400	-1 -6	-100 -600	120	53	DPAK (T1)
ZX5T1951G	-60	-6	3	100 40	- -	-0.01 -5	-30 -260	-0.1 -5	-10 -500	120	40	SOT223 (T1)
ZXTP2012G	-60	-5.5	3	100 10	300 -	-2 -10	-70 -250	-1 -5	-100 -500	120	39	SOT223 (T1)
ZX5T951G	-60	-5.5	3	100 10	300 -	-2 -10	-70 -250	-1 -5	-100 -500	120	39	SOT223 (T1)
ZXTP19060CG	-60	-5	3	200 160	500 -	-0.1 -1	-80 -205	-1 -1	-100 -20	180	50	SOT223 (T1)
FZT951	-60	-5	3	100 10	300 -	-2 -10	-140 -460	-1 -5	-100 -500	120	55	SOT223 (T1)
ZXTP19060CZ	-60	-4.5	2.4	200 160	500 -	-0.1 -1	-80 -205	-1 -1	-100 -20	180	50	SOT89 (T1)
ZXTP2012Z	-60	-4.3	2.1	100 10	300 -	-2 -10	-65 -215	-1 -5	-100 -500	120	32	SOT89 (T1)
ZXTP19060CFF	-60	-4	1.5	200 160	500 -	-0.1 -1	-200 -270	-1 -4	-20 -400	180	45	SOT23F (T1)
ZTX951	-60	-4	1.2	100 10	300 -	-1 -10	-100 -300	-1 -4	-100 -400	120	-	E-Line (T1)
ZXTP2027F	-60	-4	1.2	100	300	-2	-60	-1	-100	165	31	SOT23 (T1)
ZXTP2012A	-60	-3.5	1	100 10	300 -	-1 -10	-65 -210	-1 -4	-100 -400	120	38	E-Line (T1)
FZT751	-60	-3	2	100 40	300 -	-0.5 -2	-600	-3	-300	100	-	SOT223 (T1)
ZXTP25060BFH	-60	-3	1.25	100 30	300 -	-0.01 -3	-85 -235	-1 -3	-100 -300	250	58	SOT23 (T1)
ZTX751	-60	-2	1	100 40	300 -	-0.5 -2	-500	-2	-200	100	-	E-Line (T1)
FZT591	-60	-1	2	100	300	-0.5	-600	-1	-100	150	-	SOT223 (T1)
FCX591	-60	-1	1	100	300	-0.5	-600	-1	-100	150	-	SOT89 (T1)
ZTX551	-60	-1	1	50	150	-0.15	-350	-0.15	-15	150	-	E-Line (T1)
FMMT551	-60	-1	0.5	50	150	-0.15	-350	-0.15	-15	150	-	SOT23 (T1)
FMMT591	-60	-1	0.5	100	300	-0.5	-180 -350	-0.5 -1	-50 -100	150	355	SOT23 (T1)
ZXTP2039F	-60	-1	0.35	100 80	300	-0.5 -1	-200 -300	-0.1 -0.5	-2 -50	150	-	SOT23 (T1)
ZUMT591	-60	-1	0.33	100	300	-0.5	-300	0.5	-50	150	-	SOT323 (T1)
ZXT4M322	-70	-2.5	1.5	300 175	- -	-0.1 -1	-220 -260	-1 -1.5	-100 -200	150	117	DFN322 (T1)
FZT792A	-70	-2	2	250 200	- -	-0.5 -1	-450 -500	-0.5 -2	-5 -200	100	-	SOT223 (T1)
ZTX792A	-70	-2	1	250 200	- -	-0.5 -1	-450 -500	-0.5 -2	-5 -200	100	-	E-Line (T1)
FMMT722	-70	-1.5	0.625	300 175	- -	-0.1 -1	-220 -260	-1 -1.5	-100 -200	150	-	SOT23 (T1)
BCX5316	-80	-1	1	100	250	-0.15	-500	-0.5	-50	150	-	SOT89 (T1)
BSR33	-80	-1	1	100	300	-0.1	-500	-0.5	-50	100	-	SOT89 (T1)

# PNP transistors from 60 to 100V

Part number	V <sub>CEO</sub>	I <sub>C</sub>	P <sub>D</sub>	h <sub>FE</sub>			V <sub>CE(sat)</sub>			f <sub>T</sub>	R <sub>CE(sat)</sub>	Package
	V	A	W	Min.	Max.	@ I <sub>C</sub> A	Max. mV	@ I <sub>C</sub> A	@ I <sub>B</sub> mA			
FMMTA56	-80	-0.5	0.33	50	-	-0.1	-250	-0.1	-10	100	-	SOT23 (T1)
ZXT953K	-100	-5	4.2	100 15	300 -	-1 -5	-100 -335	-1 -5	-100 -500	125	67	DPAK (T1)
FZT953	-100	-5	-3	100 30	300 -	-1 -5	-140 -460	-1 -5	-100 -500	125	55	SOT223 (T1)
ZXTP2013G	-100	-5	3	100 15	300 -	-1 -4	-90 -340	-1 -4	-100 -400	125	60	SOT223 (T1)
ZX5T953G	-100	-5	3	100 15	300 -	-1 -4	-90 -340	-1 -4	-100 -400	125	60	SOT223 (T1)
ZXTP2013Z	-100	-3.5	2.1	100 15	300 -	-1 -4	-85 -300	-1 -4	-100 -400	125	57	SOT89 (T1)
ZTX953	-100	-3.5	1.2	100 30	300 -	-1 -4	-100 -330	-1 -4	-100 -400	125	-	E-Line (T1)
ZXTP2029F	-100	-3	1.2	100 40	300 -	-1 -3	-80 -180	-1 -3	-100 -300	150	45	SOT23 (T1)
ZXTP19100CFF	-100	-2	1.5	200 70	500 -	-0.1 -1	-120 -275	-1 -2	-10 -200	142	95	SOT23F (T1)
ZXTP19100CG	-100	-2	3	200 70	500 -	-0.1 -1	-125 -230	-1 -1	-100 -50	142	100	SOT223 (T1)
ZXTP19100CZ	-100	-2	2.4	200 70	500 -	-0.1 -1	-125 -230	-1 -1	-100 -50	142	100	SOT89 (T1)
FZT753	-100	-2	2	100 25	300 -	-0.5 -2	-500	-2	-200	140	-	SOT223 (T1)
ZXTP25100BFH	-100	-2	1.25	100 15	300 -	-0.01 -2	-130 -295	-1 -2	-100 -200	200	108	SOT23 (T1)
ZTX753	-100	-2	1	100	300	-0.5	-500	-2	-200	120	-	E-Line (T1)
ZXTP25100CZ	-100	-1	2.4	200 110	500 -	-0.01 -0.5	-315 -225	-0.5 -1	-20 -100	180	155	SOT89 (T1)
FZT593	-100	-1	2	100	300	-0.5	-300	-0.5	-50	50	-	SOT223 (T1)
ZXTP25100CFH	-100	-1	1.25	200 110	500 -	-0.01 -0.5	-310 -220	-0.5 -1	-20 -100	180	150	SOT23 (T1)
FCX593	-100	-1	1	100	300	-0.5	-300	-0.5	-50	50	-	SOT89 (T1)
ZTX553	-100	-1	1	40	200	-0.15	-250	-0.15	-15	150	-	E-Line (T1)
FMMT723	-100	-1	0.625	300 250	- -	-0.1 -0.5	-200 -330	-0.5 -1	-50 -150	200	-	SOT23 (T1)
FMMT593	-100	-1	0.5	100	300	-0.5	-300	-0.5	-50	50	-	SOT23 (T1)

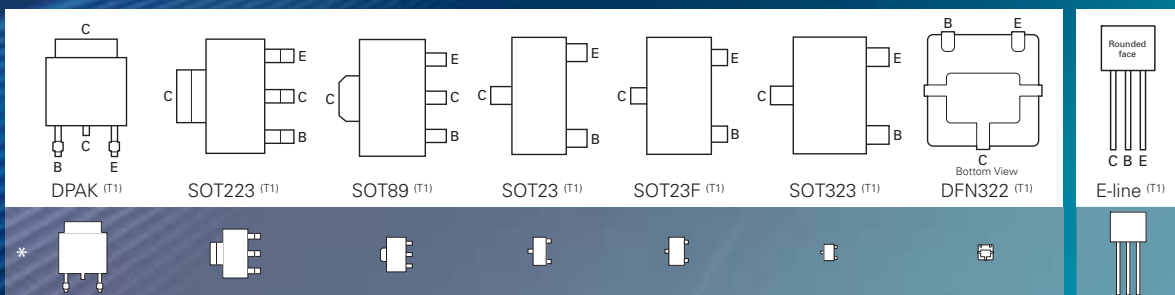

\*Indicative relative size

# NPN transistors from 120 to 220V

Part number	V <sub>CEO</sub>	I <sub>C</sub>	P <sub>D</sub>	h <sub>FE</sub>			V <sub>CE(sat)</sub>			f <sub>T</sub>	R <sub>CE(sat)</sub>	Package
	V	A	W	Min.	Max.	@ I <sub>C</sub> A	Max. mV	@ I <sub>C</sub> A	@ I <sub>B</sub> mA	MHz	mΩ	
FZT694B	120	1	2	400	-	0.2	250	0.1	0.5	130	-	SOT223 (T1)
FMMT494	120	1	0.5	100	300	0.25	200	0.25	25	100	-	SOT23 (T1)
ZTX694B	120	0.5	1	400	-	0.2	250	0.1	0.5	130	-	E-Line (T1)
FMMT624	125	1	0.625	300 100	- -	0.2 1	220 250	0.5 1	10 50	100	-	SOT23 (T1)
ZTX455	140	1	1	100	300	0.15	700	0.15	15	100	-	E-Line (T1)
FMMT455	140	1	0.5	100	300	0.15	700	0.15	15	100	-	SOT23 (T1)
FZT855	150	5	3	100 15	300 -	1 5	65 355	0.5 5	50 500	90	-	SOT223 (T1)
ZTX855	150	4	1.2	100 35	300 -	1 4	60 260	0.5 4	50 400	90	-	E-Line (T1)
FCX495	150	1	1	100	300	0.25	300	0.5	50	100	-	SOT89 (T1)
FZT655	150	1	2	50	300	0.5	500	0.5	50	30	-	SOT223 (T1)
FMMT625	150	1	0.625	300 30	- -	0.2 1	200 300	0.1 1	1 50	100	-	SOT23 (T1)
FMMT495	150	1	0.5	100	300	0.25	300	0.5	50	100	-	SOT23 (T1)
ZXTN5551FL	160	0.6	0.35	80	250	0.01	150	0.01	1	130	-	SOT23 (T1)
ZXTN5551Z	160	0.6	1.2	80	250	0.01	150	0.01	1	130	-	SOT89 (T1)
ZXTN5551G	160	0.6	2	80	250	0.01	150	0.01	1	130	-	SOT223 (T1)
FZT696B	180	0.5	2	500	-	0.1	250	0.2	5	70	-	SOT223 (T1)
ZTX696B	180	0.5	1	500	-	0.1	250	0.2	5	70	-	E-Line (T1)
ZXTN5551EFL*	220	0.6	0.35	120	300	0.01	100	0.05	5	100		SOT23 (T1)
ZXTN5551EZ*	220	0.6	1.2	120	300	0.01	100	0.05	5	100		SOT223 (T1)
ZXTN5551EG*	220	0.6	2	120	300	0.01	100	0.05	5	100		SOT89 (T1)

\* Advance information



# PNP transistors from 120 to 220V

Part number	V <sub>CEO</sub>	I <sub>C</sub>	P <sub>D</sub>	h <sub>FE</sub>			V <sub>CE(sat)</sub>			f <sub>T</sub>	R <sub>CE(sat)</sub>	Package
	V	A	W	Min.	Max.	@ I <sub>C</sub> A	Max. mV	@ I <sub>C</sub> A	@ I <sub>B</sub> mA			
FZT955	-140	-4	3	100 75	300 -	-1 -3	-370	-3	-300	110	-	SOT223 (T1)
ZXTP2014G	-140	-4	3	100 45	300 -	-1 -3	-80 -360	-0.5 -3	-50 -300	120	92	SOT223 (T1)
ZX5T955G	-140	-4	3	100 45	300 -	-1 -3	-80 -360	-0.5 -3	-50 -300	120	85	SOT223 (T1)
ZXTP2014Z	-140	-3	2.1	100 45	300 -	-1 -3	-75 -330	-0.5 -3	-50 -300	120	85	SOT89 (T1)
ZX5T955Z	-140	-3	2.1	100 45	300 -	-0.5 -3	-75 -330	-0.5 -3	-50 -300	120	-	SOT89 (T1)
ZTX955	-140	-3	1.2	100 75	300 -	-1 -3	-330	-3	-300	110	-	E-Line (T1)
ZXTP23140BFH	-140	-2.5	1.25	100 40	300 -	1 -2.5	-95 -280	-1 -2.5	-100 -250	130	76	SOT23 (T1)
ZXTP25140BFH	-140	-1	1.25	100 20	300 -	-0.01 -1	-50 -260	-0.1 -1	-10 -100	75	180	SOT23 (T1)
FZT795A	-140	-0.5	2	250	-	-0.2	-300	-0.2	-5	100	-	SOT223 (T1)
ZTX795A	-140	-0.5	1	250	-	-0.2	-300	-0.2	-5	100	-	E-Line (T1)
FZT755	-150	-1	2	50	300	-0.5	-500	-1	-200	100	-	SOT223 (T1)
FMMT555	-150	-1	0.5	50	300	-0.3	-300	-0.1	-10	100	-	SOT23 (T1)
ZXTP5401FL	-150	-0.6	0.35	60	240	-0.01	-200	-0.01	-1	100	-	SOT23 (T1)
ZXTP5401Z	-150	-0.6	1.2	60	240	-0.01	-200	-0.01	-1	100	-	SOT223 (T1)
ZXTP5401G	-150	-0.6	2	60	240	-0.01	-200	-0.01	-1	100	-	SOT89 (T1)
FCX555	-180	-0.7	1.5	100 100	- 300	-0.01 -0.1	-300 -400	-0.1 -0.25	-10 -25	100	-	SOT89 (T1)
FZT956	-200	-2	3	100 50	300 -	-1 -2	-275	-2	-400	110	-	SOT223 (T1)
ZXTP03200BG*	-200	-2	3	100 35	300 -	-1 -2	-50 -160	-0.1 -1	-10 -100	120	120	SOT223 (T1)
ZTX956	-200	-2	1.2	100 50	300 -	-1 -2	-250	-2	-400	110	-	E-Line (T1)
FZT796A	-200	-0.5	2	250	-	-0.3	-300	-0.2	-20	100	-	SOT223 (T1)
ZTX796A	-200	-0.5	1	250	-	-0.3	-300	-0.2	-20	100	-	E-Line (T1)
FCX596	-200	-0.3	1	85	300	-0.25	-350	-0.25	-25	150	-	SOT89 (T1)
FMMT596	-200	-0.3	0.5	85	300	-0.25	-350	-0.25	-25	150	-	SOT23 (T1)
ZXTP5401EFL*	-220	-0.6	0.35	100	300	-0.01	-150	-0.05	-5	100	-	SOT23 (T1)
ZXTP5401EZ*	-220	-0.6	1.2	100	300	-0.01	-150	-0.05	-5	100	-	SOT223 (T1)
ZXTP5401EG*	-220	-0.6	2	100	300	-0.01	-150	-0.05	-5	100	-	SOT89 (T1)

\* Advance information

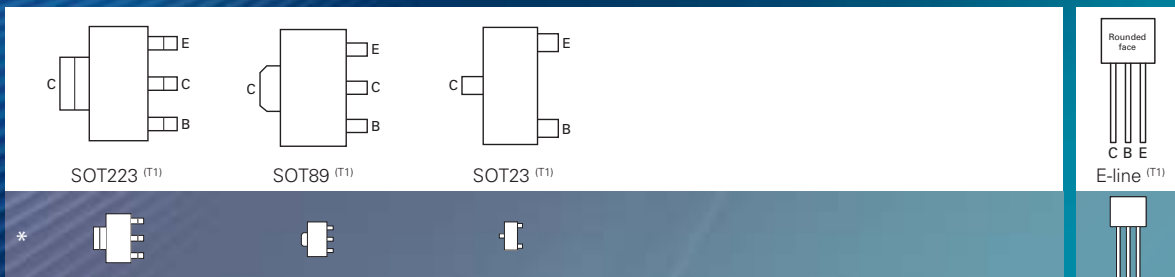

\*Indicative relative size

## NPN transistors from 300 to 500V

Part number	$V_{CE0}$	$I_C$	$P_D$	$h_{FE}$			$V_{CE(sat)}$			$f_T$ MHz	$R_{CE(sat)}$ m $\Omega$	Package
	V	A	W	Min.	Max.	@ $I_C$ A	Max. mV	@ $I_C$ A	@ $I_B$ mA			
FZT857	300	3.5	3	100	300	0.5	230	2	200	80	-	SOT223 (T1)
ZTX857	300	3	1.2	100	300	0.5	250	3	600	80	-	E-Line (T1)
FZT657	300	0.5	2	50	-	0.1	500	0.1	10	30	-	SOT223 (T1)
FZTA42	300	0.5	2	40	-	0.03	500	0.02	2	50	-	SOT223 (T1)
SXTA42	300	0.5	1	40	-	0.03	500	0.02	2	50	-	SOT89 (T1)
ZTX457	300	0.5	1	50	300	0.05	300	0.1	10	75	-	E-Line (T1)
ZTX657	300	0.5	1	50	-	0.1	500	0.1	10	30	-	E-Line (T1)
FMMT497	300	0.5	0.5	80	300	0.1	200	0.1	10	75	-	SOT23 (T1)
FMMTA42	300	0.2	0.33	40	-	0.03	500	0.02	2	50	-	SOT23 (T1)
BST39	350	0.5	1	40	-	0.02	500	0.05	4	70	-	SOT89 (T1)
FMMT6517	350	0.5	0.33	30	200	0.03	500	0.03	3	50	-	SOT23 (T1)
FZT658	400	0.5	2	50	-	0.1	500	0.1	10	50	-	SOT223 (T1)
ZXTN08400BFF	400	0.5	1.5	100 10	300 -	0.05 0.5	70 170	0.05 0.3	5 30	40	-	SOT23F (T1)
FCX658A	400	0.5	1	55	-	0.1	200	0.2	10	50	-	SOT89 (T1)
ZTX658	400	0.5	1	50	-	0.1	500	0.1	10	50	-	E-Line (T1)
FZT458	400	0.3	2	100	300	0.05	500	0.05	6	50	-	SOT223 (T1)
ZTX458	400	0.3	1	100	300	0.05	500	0.05	6	50	-	E-Line (T1)
FCX458	400	0.225	1	100	300	0.05	500	0.05	6	50	-	SOT89 (T1)
FMMT458	400	0.225	0.5	100	300	0.05	500	0.05	6	50	-	SOT23 (T1)
FMMT459	500	0.15	0.625	50	-	0.03	75	0.02	2	50	-	SOT23 (T1)

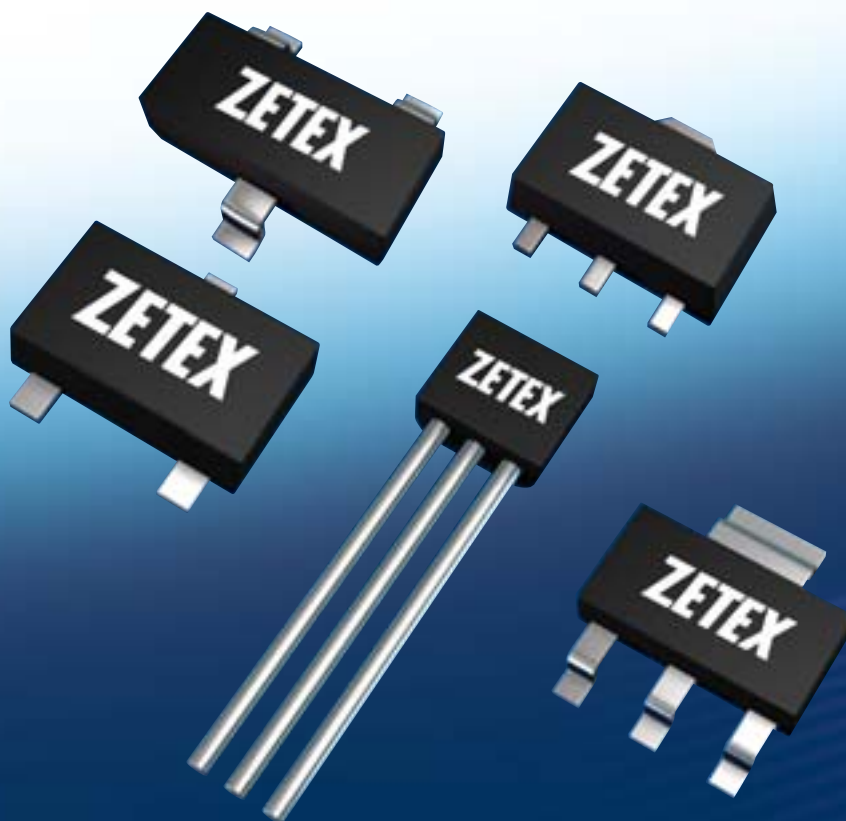

# PNP transistors from 300 to 500V

Part number	V <sub>CEO</sub>	I <sub>C</sub>	P <sub>D</sub>	h <sub>FE</sub>			V <sub>CE(sat)</sub>			f <sub>T</sub>	R <sub>CE(sat)</sub>	Package
	V	A	W	Min.	Max.	@ I <sub>C</sub> A	Max. mV	@ I <sub>C</sub> A	@ I <sub>B</sub> mA			
FZT957	-300	-1	3	100	300	-0.5	-240	-1	-300	85	-	SOT223 (T1)
ZTX957	-300	-1	1.2	100	300	-0.5	-200	-1	-300	85	-	E-Line (T1)
FZT757	-300	-0.5	2	40	-	-0.01	-500	-0.1	-10	30	-	SOT223 (T1)
FZTA92	-300	-0.5	2	25	-	-0.03	-500	-0.02	-2	50	-	SOT223 (T1)
ZTX757	-300	-0.5	1	40	-	-0.01	-500	-0.1	-10	30	-	E-Line (T1)
FMMT597	-300	-0.2	0.5	100	-	-0.1	-250	-0.1	-20	75	-	SOT23 (T1)
FMMTA92	-300	-0.2	0.33	25	-	-0.03	-500	-0.02	-2	50	-	SOT23 (T1)
FMMT6520	-350	-0.5	0.33	30	200	-0.03	-500	-0.03	-3	50	-	SOT23 (T1)
FZT958	-400	-0.5	3	100	300	-0.5	-400	-0.5	-100	85	-	SOT223 (T1)
ZTX958	-400	-0.5	1.2	100	300	-0.5	-400	-0.5	-100	85	-	E-Line (T1)
FZT758	-400	-0.5	2	50	-	-0.1	-500	0.1	-10	50	-	SOT223 (T1)
ZTX758	-400	-0.5	1	50	-	-0.1	-500	-0.1	-10	50	-	E-Line (T1)
FZT558	-400	-0.2	2	100	300	-0.05	-500	-0.05	-6	50	-	SOT223 (T1)
ZXTP08400BFF	-400	-0.2	1.5	100 100	300 -	-0.05 -0.2	-125 -190	-0.05 -0.2	-5 -40	70	-	SOT23F (T1)
FCX558	-400	-0.2	1	100	300	-0.05	-500	-0.05	-6	50	-	SOT89 (T1)
ZTX558	-400	-0.2	1	100	300	-0.05	-500	-0.05	-6	50	-	E-Line (T1)
FMMT558	-400	-0.15	0.5	100	300	-0.05	-500	-0.05	-6	50	-	SOT23 (T1)
FZT560	-500	-0.15	2	80	300	-0.05	-200	-0.02	-2	60	-	SOT223 (T1)
ZTX560	-500	-0.15	1	80	300	-0.05	-200	0.02	-2	60	-	E-Line (T1)
FMMT560	-500	-0.15	0.5	80	300	-0.05	-200	-0.02	-2	60	-	SOT23 (T1)

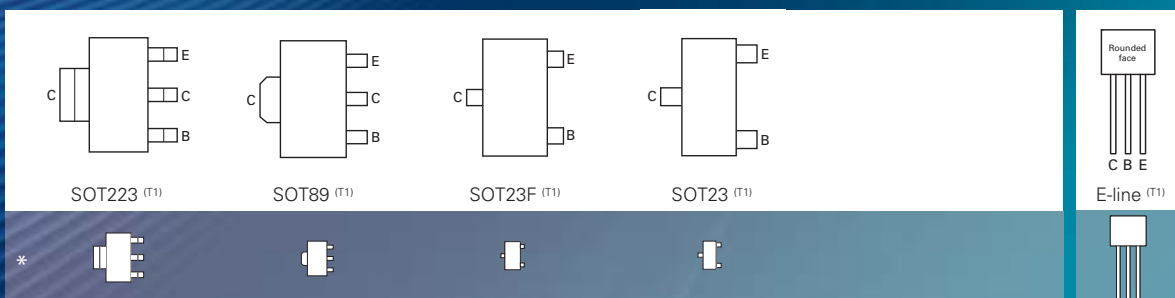

\*Indicative relative size

## NPN avalanche transistors

Part number	$V_{CBO}$	$V_{CEO}$	$I_{CM}$	$P_D$	$I_{USB}$		$h_{FE}$		$f_T$		Package
	V	V	A	W	A	@ $V_C$ V	Min.	@ $I_C$ mA	MHz	@ $I_B$ mA	
FMMT413	150	50	50	0.33	25	130	50	10	150	10	SOT23 (T1)
FMMT415	260	100	60	0.33	25	250	25	10	40	10	SOT23 (T1)
ZTX415	260	100	60	0.68	25	250	25	10	40	10	E-Line (T1)
FMMT417	320	100	60	0.33	25	250	25	10	40	10	SOT23 (T1)

## NPN Darlington transistors

Part number	$V_{CEO}$	$I_C$	$P_D$	$h_{FE}$			$V_{CE(sat)}$			$f_T$	Package
	V	A	W	Min.	Max.	@ $I_C$ A	Max. mV	@ $I_C$ A	@ $I_B$ mA	MHz	
FZTA14	30	1	2	5000	-	1	1600	1	1	170	SOT223 (T1)
FMMTA13	40	0.3	0.33	10000	-	0.1	900	0.1	0.1	-	SOT23 (T1)
FMMTA14	40	0.3	0.33	20000	-	0.1	900	0.1	0.1	-	SOT23 (T1)
BCV47	60	0.5	0.33	2000	-	0.5	1000	0.1	0.1	170	SOT23 (T1)
BCV49	60	0.5	1	10000	-	0.1	1000	0.1	0.1	170	SOT89 (T1)
BCX38C	60	0.8	1	10000	-	0.5	1250	0.8	8	-	E-Line (T1)
FMMT38C	60	0.3	0.33	10000	-	0.5	1250	0.8	8	-	SOT23 (T1)
BST52	80	0.5	1	2000	-	0.5	1300	0.5	0.5	-	SOT89 (T1)
FZT603	80	2	2	2000	-	2	1000	1	1	150	SOT223 (T1)
ZTX603	80	1	1	5000	-	0.5	1000	1	1	150	E-Line (T1)
FMMT614	100	0.5	0.5	5000	-	0.5	1000	0.5	5	-	SOT23 (T1)
FMMT634	100	0.9	0.625	15000	-	1	960	1	5	140	SOT23 (T1)
ZTX614	100	0.8	1	10000	-	0.5	1250	0.8	8	-	E-Line (T1)
ZXTN04120HFF	120	1	1.5	3000 1000	- -	0.5 2	1500 1500	1 2	1 5	120	SOT23F (T1)
FCX605	120	1	1	2000	100000	1	1500	1	1	150	SOT89 (T1)
FZT605	120	1.5	2	2000	100000	1	1500	1	1	150	SOT223 (T1)
ZTX605	120	1	1	2000	100000	1	1500	1	1	150	E-Line (T1)
FZT600	140	2	2	2000	100000	0.5	1200	1	10	150	SOT223 (T1)
FZT600B	140	2	2	10000	100000	0.5	1200	1	10	150	SOT223 (T1)
ZTX601	160	1	1	2000	100000	0.5	1200	1	10	150	E-Line (T1)
ZTX601B	160	1	1	10000	100000	0.5	1200	1	10	150	E-Line (T1)

## PNP Darlington transistors

Part number	$V_{CEO}$	$I_C$	$P_D$	$h_{FE}$			$V_{CE(sat)}$			$f_T$	Package
	V	A	W	Min.	Max.	@ $I_C$ A	Max. mV	@ $I_C$ A	@ $I_B$ mA	MHz	
FMMT734	-100	-0.8	0.625	15000	-	-1	-970	-0.8	-5	140	SOT23 (T1)
ZXTP05120HFF	-120	-1	1.5	3000 1000	- -	-0.5 -2	-1500 -1500	-1 -2	-1 -5	120	SOT23F (T1)
FCX705	-120	-1	1	3000	30000	-1	-1300	-1	-1	160	SOT89 (T1)
FZT705	-120	-2	2	3000	30000	-1	-1300	-1	-1	160	SOT223 (T1)
ZTX705	-120	-1	1	3000	30000	-1	-1300	-1	-1	160	E-Line (T1)

# H-bridges

Part number	Polarity	$V_{CEO}$	$I_C$	$P_D$	$h_{FE}$		$V_{CE(sat)}$			Package
		V	A	W	Min.	@ $I_C$ A	Max. mV	@ $I_C$ A	@ $I_B$ mA	
ZHB6718	2 x NPN 2 x PNP	20 -20	2.5 -2.5	2	200 150	2 -2	0.15 -0.2	1 -1	10 -20	SM8 (T3)
ZHB6790	2 x NPN 2 x PNP	40 -40	2 -2	2	150 150	2 -2	0.5 -0.45	1 -1	5 -10	SM8 (T3)
ZHB6792	2 x NPN 2 x PNP	70 -70	1 -1	2	150 200	1 -1	0.5 -0.5	1 -1	10 -25	SM8 (T3)

## NPN/PNP combinations

Part number	Polarity	$V_{CEO}$	$I_C$	$I_{CM}$	$P_D$	$h_{FE}$		$V_{CE(sat)}$			Package
		V	A	A	W	Min.	@ $I_C$ A	Max. mV	@ $I_C$ A	@ $I_B$ mA	
ZXTC2061E6	NPN PNP	12 -12	5 -3.5	12 -10	1.1	500 500	0.01 -0.01	40 -70	1 -1	100 -100	SOT23-6 (T2)
ZXTDA1M832	NPN PNP	15 -12	4.5 -4	15 -12	1.5	200 180	3 -2.5	100 -140	1 -1	10 -10	DFN832 (T2)
ZXTD6717E6	NPN PNP	15 -12	1.5 -1.25	5 -3	1.1	200 200	1 -0.5	200 -215	1 -1	10 -50	SOT23-6 (T2)
ZXTC2062E6	NPN PNP	20 -20	4.5 -3.5	10 -10	1.1	300 300	0.01 -0.01	50 -65	1 -1	100 -100	SOT23-6 (T2)
ZXTDB2M832	NPN PNP	20 -20	4.5 -3.5	12 -6	1.5	200 150	2 -2	150 -220	1 -1	10 -20	DFN832 (T2)
ZDT6718	NPN PNP	20 -20	2 -1.5	6 -6	2.5	200 150	2 -2	200 -220	2.5 -1.5	50 -50	SM8 (T2)
ZXTC2045E6	NPN PNP	30 -30	1.5 -1.5	5 -5	1.1	180 180	0.1 -0.1	375 -375	0.75 -0.75	15 -15	SOT23-6 (T2)
ZXTD4591AM832	NPN PNP	40 -40	2 -1.5	3 -3	1.5	300 250	0.5 -0.5	300 -350	0.5 -0.5	50 -20	DFN832 (T2)
ZDT6790	NPN PNP	45 -40	2 -2	6 -6	2.75	150 150	2 -2	500 -450	1 -1	5 -10	SM8 (T2)
ZXTDC3M832	NPN PNP	50 -40	4 -3	6 -4	1.5	200 180	1 -1	100 -220	1 -1	50 -50	DFN832 (T2)
ZXTC2063E6	NPN PNP	40 -40	3.5 -3	9 -9	1.1	300 300	0.01 -0.01	60 -90	1 -1	100 -100	SOT23-6 (T2)
ZXTD4591E6	NPN PNP	60 -60	1 -1	2 -2	1.1	100 100	0.5 -0.5	250 -300	0.5 -0.5	50 -50	SOT23-6 (T2)
ZXTDE4M832	NPN PNP	80 -70	3.5 -2.5	5 -3	1.5	110 175	1 -1	185 -220	1 -1	20 -100	DFN832 (T2)
ZDT6753	NPN PNP	100 -100	2 -2	6 -6	2.75	100 100	0.5 -0.5	500 -500	2 -2	200 -200	SM8 (T2)

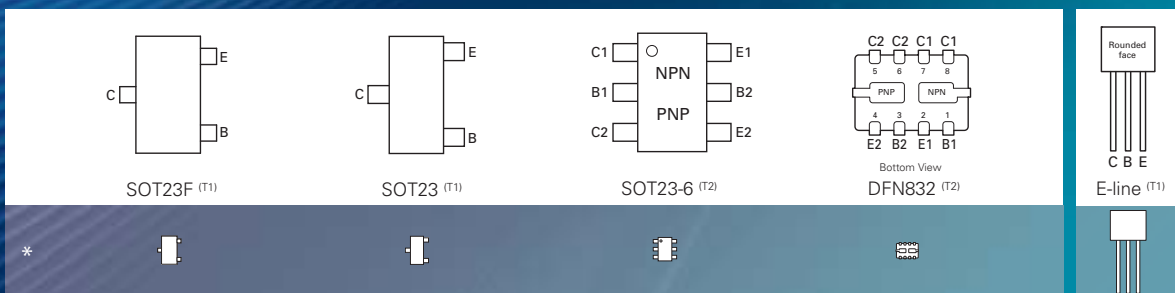
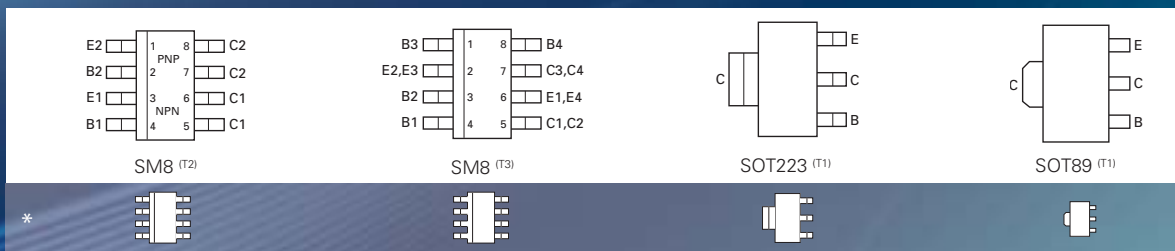

\* Indicative relative size

## Dual NPN transistors

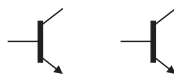

Part number	Polarity	$V_{CE0}$	$I_C$	$P_D$	$h_{FE}$		$V_{CE(sat)}$			Package
		V	A	W	Min.	@ $I_C$ A	Max. mV	@ $I_C$ A	@ $I_B$ mA	
ZXTDAM832	2 x NPN	15	4.5	1.5	200	3	100 280	1 4.5	10 50	DFN832 (T1)
ZDT1048	2 x NPN	17.5	5	2.75	250	5	240	5	100	SM8 (T1)
ZXTDBM832	2 x NPN	20	4.5	1.5	200	2	150 270	1 4.5	10 125	DFN832 (T1)
ZXT12N20DX	2 x NPN	20	3.5	1.25	300 200	1 3.5	100 200	1 3.5	10 50	MSOP8 (T1)
ZDT1049	2 x NPN	25	5	2.75	200	4	220	4	50	SM8 (T1)
ZXT12N50DX	2 x NPN	50	3	1.25	300 150	1 3	120 250	1 3	10 50	MSOP8 (T1)
ZXTD09N50DE6	2 x NPN	50	1	1.1	300	1	270	1	50	SOT23-6 (T3)
ZXTDCM832	2 x NPN	50	4	1.5	200	1	100	1	50	DFN832 (T1)
ZDT1053	2 x NPN	75	5	2.75	300	1	440	5	250	SM8 (T1)
ZDT694	2 x NPN	120	0.5	2.75	400	0.2	500	0.4	5	SM8 (T1)
ZXTD2075E6*	2 x NPN	300	0.2	1.1	40	0.03	200	0.02	2	SOT23-6 (T1)

\* Advance information

## Dual PNP transistors



Part number	Polarity	$V_{CE0}$	$I_C$	$P_D$	$h_{FE}$		$V_{CE(sat)}$			Package
		V	A	W	Min.	@ $I_C$ A	Max. mV	@ $I_C$ A	@ $I_B$ mA	
ZXTD1M832	2 x PNP	-12	-4	1.5	180	-2.5	-140 -300	-1 -4	-10 -150	DFN832 (T1)
ZXT12P12DX	2 x PNP	-12	-3	1.25	300 200	-1 -3	-85 -270	-1 -3	-20 -30	MSOP8 (T1)
ZXTD2M832	2 x PNP	-20	-3.5	1.5	150	-2	-220 -300	-1 -3.5	-20 -350	DFN832 (T1)
ZDT749	2 x PNP	-25	-2	2.75	75	-2	-500	-2	-200	SM8 (T1)
ZXT12P40DX	2 x PNP	-40	-2	1.25	300 150	-1 -2	-215 -260	-1 -2	-20 -100	MSOP8 (T1)
ZDT751	2 x PNP	-60	-2	2.75	80	-1	-500	-2	-200	SM8 (T1)
ZDT795A	2 x PNP	-140	-0.5	2.75	250	-0.2	-300	-0.2	-5	SM8 (T1)

# Transistor and Schottky diode combinations

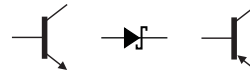

Part number	Polarity	V <sub>CEO</sub>	I <sub>c</sub>	P <sub>D</sub>	Transistor						Schottky diode		Package	
					V <sub>R</sub>	I <sub>F</sub>	h <sub>FE</sub>		R <sub>CE(sat)</sub>	V <sub>CE(sat)</sub>		V <sub>F</sub> max		@ I <sub>F</sub>
							Min.	@ I <sub>c</sub>	Typ.	Max.	@ I <sub>c</sub>			
V	A	W		mΩ	V	A	mA	V	A					
ZX3CD1S1M832	PNP Diode	-12 40	-4 1.85	1.5 1.2	300	-0.1	60	-0.14	-1	-10	- 0.5	- 1	DFN832 (T3)	
ZX3CDBS1M832	NPN Diode	20 40	4.5 1.85	1.5 1.2	300	0.2	47	0.15	1	10	- 0.5	- 1	DFN832 (T3)	
ZX3CD2S1M832	PNP Diode	-20 40	-3.5 1.85	1.5 1.2	300	-0.1	64	-0.22	-1	-20	- 0.5	- 1	DFN832 (T3)	
ZX3CD3S1M832	PNP Diode	-40 40	-3 1.85	1.5 1.2	300	-0.1	104	-0.22	-1	-50	- 0.5	- 1	DFN832 (T3)	

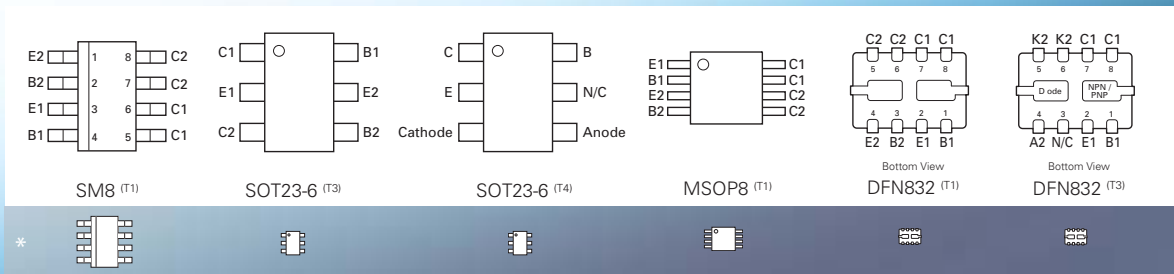

# Gate drive transistors

- Fast switching emitter-follower configuration
- SOT23-6 package
- Optimised pin-out to ease board layout and minimize trace inductance
- Separate emitters for independent control of rise and fall time
- Low input current requirement
- No latch up
- No shoot through
- Near zero quiescent and output leakage current

Part number	V <sub>IN</sub> Max V	V <sub>CC</sub> Max V	I <sub>source</sub> @ I <sub>IN</sub> = 10mA A	I <sub>sink</sub> A	I <sub>sinkPK</sub> Max A	I <sub>IN</sub> Max A	Gate Driver Switching Times (typ)				@ Condition	Package
							t <sub>d(rise)</sub> ns	t <sub>r</sub> ns	t <sub>d(fall)</sub> ns	t <sub>f</sub> ns		
ZXGD3001E6	12	12	4.2	2.2	9	1.0	1.3	7.3	3	11	C <sub>L</sub> = 1nF, R <sub>L</sub> = 1Ω, V <sub>CC</sub> = 8V, V <sub>IN</sub> = 6V, R <sub>S</sub> = 25Ω	SOT23-6 (T6)
ZXGD3002E6	20	20	2.2	2.0	9	1.0	1.25	8.3	1.6	10.8	C <sub>L</sub> = 1nF, R <sub>L</sub> = 1Ω, V <sub>CC</sub> = 12V, V <sub>IN</sub> = 10V, R <sub>S</sub> = 25Ω	SOT23-6 (T6)
ZXGD3003E6	40	40	1.6	1.4	5	1.0	1.8	8.9	1.7	8.9	C <sub>L</sub> = 1nF, R <sub>L</sub> = 1Ω, V <sub>CC</sub> = 12V, V <sub>IN</sub> = 10V, R <sub>S</sub> = 25Ω	SOT23-6 (T6)
ZXGD3004E6	40	40	1.9	1.9	8	1.0	1.1	13.4	0.95	12.4	C <sub>L</sub> = 1.5nF, R <sub>L</sub> = 0.1Ω, V <sub>CC</sub> = 15V, V <sub>IN</sub> = 12.5V, R <sub>S</sub> = 25Ω	SOT23-6 (T6)

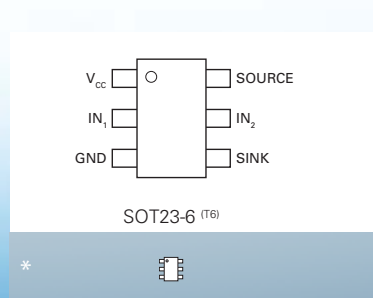

\*Indicative relative size

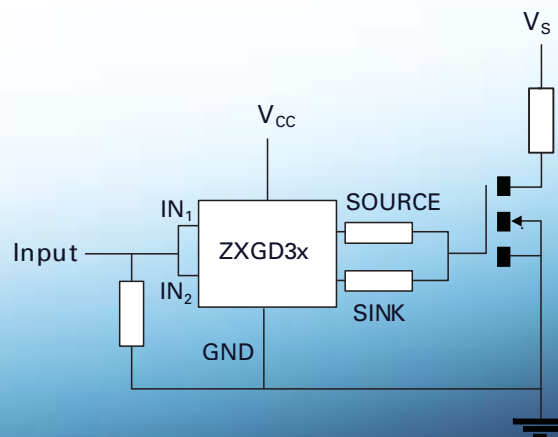





# Article

## Applications dictate bipolar or MOSFET power switch choices

### Section 1.1

**Bipolar transistors have continued to be developed to rival or exceed MOSFET performance in many applications. It's therefore important to review the characteristics and benefits of each technology to extract the best system performance.**

The first characteristic that designers often consider is on-state resistance for a given breakdown voltage. Figure 1 shows the rapid advances made by Zetex in recent years. Furthermore, bipolar transistors benefit from conductivity modulation, an effect that increases the advantage that the bipolar transistors hold over MOSFETs as breakdown voltages increase.

Also, don't forget that bipolar transistors block voltage in two directions, as specified by their  $BV_{EBO}$  or  $BV_{ECO}$  characteristic which can eliminate the need for a series diode and its attendant conduction losses. (See Application example 1.)

How resistance changes with temperature affects the current capability of a power switch. The rise in bipolar  $R_{CE(sat)}$  is generally half that of a MOSFET's equivalent  $R_{DS(on)}$  leading to cooler running and higher continuous currents.

Drive requirements are arguably where bipolars and MOSFETs differ most and care must be taken to account for the bipolar's base drive loss in power dissipation calculations. However, bipolars are fully turned on at around one volt, whereas the achievable  $R_{DS(on)}$  of a MOSFET may be limited in low voltage applications by the available drive voltage over threshold.

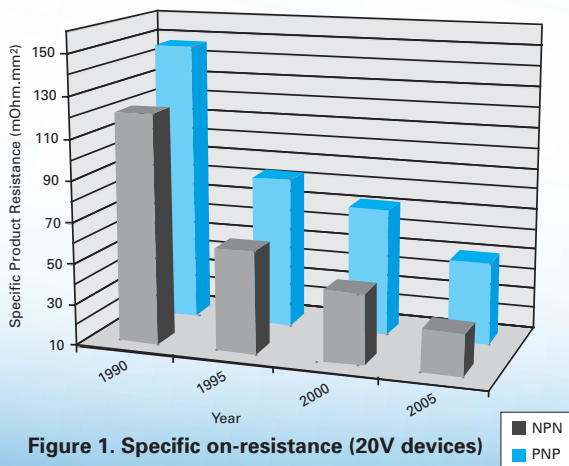

**Figure 1. Specific on-resistance (20V devices)**

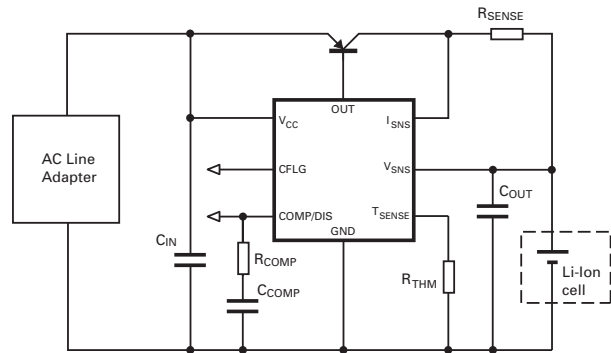

**Figure 2. A typical linear charger circuit**

Bipolars are slower switching than MOSFETs when operated as a saturated switch, provided the MOSFET has a sufficiently high-current drive. Ironically perhaps, bipolars are often employed as MOSFET pre-drivers, exploiting their high-current capabilities and fast switching speed when operating in the linear region (see Application example 2).

By understanding the relative strengths and weaknesses of each technology the performance-cost relationship can be maximized. A summary of the key parametric differences of the competing technologies appears in the table opposite.

#### Application example 1: Linear mode battery charging

Linear chargers are simple, small, and emit no EMI making them suitable for low noise environments. They use an external pass element to drop the voltage from the input supply to the battery voltage thus power dissipation is high. A typical linear charger circuit is shown in Figure 2.

Power losses in the transistor are dominated by the collector-emitter losses:

$$P_{D(CE)} = I_{CHG} \times (V_{IN} - V_{DCD} - V_{SENSE}) \text{ (W)}$$

$$\text{where } V_{SENSE} = I_{CHG} \times R_{SENSE} \text{ (V)}$$

and the selection criteria usually include current capability, gain, cost, and package dissipation. Bipolar PNP transistors are advantageous in this application because of their bi-directional blocking capability, whereas a MOSFET requires a series Schottky diode to prevent current flowing from the battery to the supply, through its body diode.

#### Application example 2: MOSFET gate drivers

High current low  $R_{DS(on)}$  MOSFETs can exhibit gate capacitances that require amps of drive current. For example, a typical 100V MOSFET with a gate charge of 50nC, requires 2.5 amps to switch in 20ns.

Bipolar transistors are ideally suited as gate drivers because they feature fast switching in linear mode, high pulse-current capability, and high current density - hence small size and cost. One of the most popular and cost-effective drive circuits is a bipolar, non-inverting totem-pole driver (see Figure 3)

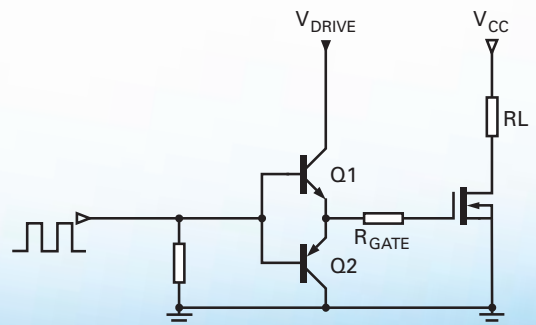

**Figure 3. Totem-pole driver stage for power MOSFET**

Characteristic	Bipolar transistor	MOSFET
'On' resistance	Excellent - down to half that of the best MOSFET, depending on drive current available.	Good at full enhancement Moderate at low gate drive
Blocking voltage	Bi-directional blocking capability. $BV_{CES}$ , $BV_{CEV}$ or $BV_{CBO}$ may be appropriate for some applications.	Mono-directional, may require a series Schottky diode or back-to-back MOSFET pair in some applications.
Pulse current	High	Moderate
Drive voltage	Less than 1V	1.8V to 10V, depending on the optimization
Temperature stability	Excellent: $V_{BE}$ : approx. 2mV per °C $R_{CE(sat)}$ approx. 0.4% per °C	$R_{DS(on)}$ approx. 0.6% per °C
Drive power	Moderate	High frequency: moderate
Speed	Linear switch: very fast Saturated switch: moderate	Fast
ESD sensitivity	Very rugged	Sensitive
Price per area of silicon	Comparable	Comparable

If the MOSFET is required to switch at 1MHz from a 5V drive the power dissipation in each driver transistor can be estimated as:

$$P_{D(npn)} = ((V_{DRIVE} - (V_G/2)) \times Q \times f) + (V_{BE} \times I_B \times t \times f)$$

$$P_{D(pnp)} = (V_G/2 \times Q \times f) + (V_{BE} \times I_B \times t \times f)$$

With both devices dissipating just 256mW, small surface mount bipolar transistors are ideal, preferably co-packaged as complementary dual devices.

**Application example 3: Resonant converter for CCFL backlight applications**

The backlight module of an LCD display requires high efficiency operation and is sensitive to cost. There are two basic circuit topologies for driving the CCFL lamps:

- a) Resonant converter, using a bipolar transistor half-bridge, or
- b) IC controller plus MOSFET half-bridge.

Resonant converter circuits are cheaper than IC controller/ MOSFET solutions and, with careful optimization, efficiencies of greater than 90% can be achieved. A simplified circuit is shown in Figure 4:

**LCD Backlight**

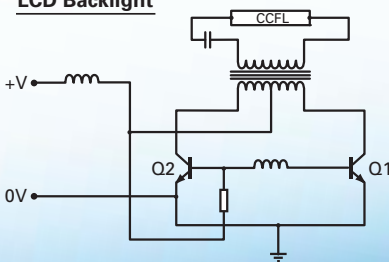

**Figure 4. Resonant converter for LCD backlight**

The important power switch selection characteristics are voltage rating, on-state resistance, gain and cost. The circuit makes use of the reverse  $BV_{EBO}$  rating and allows the use of the  $BV_{CEV}$ , or  $BV_{CES}$  characteristic, thus allowing a lower  $BV_{CEO}$  rated device with a lower on-state resistance than its MOSFET equivalent.

**Application example 4: DC brushless motor driving**

Brushless DC motors are popular due to their high efficiency, high torque, longer operating life, reduced noise and lower EMI.

Commutation is effected by switching the current in the windings of the stator in the required sequence to produce a rotating magnetic field synchronous with the rotor. Single phase, 2-phase or 3-phase motors, require respectively 1, 2 or 3 stator windings. Speed control is usually achieved by PWM.

In 2-phase circuits each winding is energized for half of the time and is switched by a single drive transistor. In single-phase bridge circuits (Figure 5) the winding current is synchronously commutated by switching diagonal pairs of transistors, therefore the single winding results in a cheaper, lighter motor but the drive circuitry is more complex.

In 3-phase bridge circuits a third leg is added to the bridge which means that both motor and drive costs are higher.

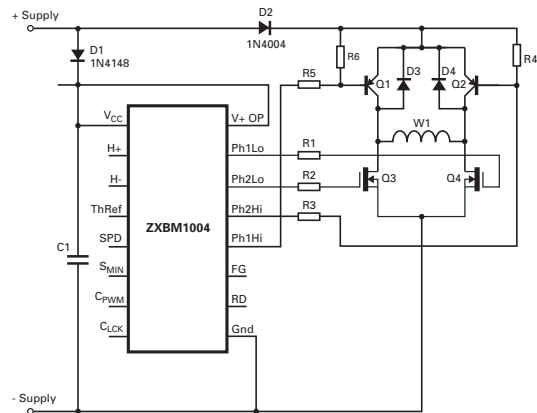

**Figure 5. Single-phase fan motor circuit**

Common to all circuit types, the requirements of the switch are to be directly driven by the control circuit; to minimize the voltage drop in the power switch in order to maximize rotor speed and circuit efficiency; to survive stall currents and inductive transients during switching.

In low voltage, low current applications e.g. PC fans, where IC motor controllers are required to operate on 3V rails, there are opportunities to make effective use of a bipolar transistor's high current gain hold-up and low  $V_{CE(sat)}$  at low drive voltages where MOSFETs struggle to be cost effective. The fan motor circuit in Figure 5 is a hybrid bridge circuit where PNP bipolar transistors are used for the high side pair, and N-Channel MOSFETs are used for the low side PWM driven pair. This combination takes advantage of the PNP transistor's low  $R_{CE(sat)}$  which helps achieve high rotor speed.

To read this article in full, go to [www.zetex.com/thinkbipolar](http://www.zetex.com/thinkbipolar)

# Diodes

## Section 2.0

### Schottky diodes

The ZHCS series of Schottky diodes provides low-loss rectification at ampere-level currents from 40 to 60V in a range of packages. Specifications that characterize each device's maximum forward voltage at its maximum operating current ease worst-case design calculations.

The ZLLS series extends this class-leading performance to minimize reverse leakage at elevated temperatures. These 40V devices also offer the ability to rectify more than 2A from within a SOT23 outline.

### Varactor (tuner) diodes

Designed around two specific C-V curves, the portfolio comprises a range of capacitance variants in a selection of miniature surface mount packages.

Developed for high Q at low voltage and with inherent low phase noise, the devices are ideal for various tuning circuits found in such products as DAB radios and crystal oscillators.

### Power rectifier diodes

The BYY and BYP series of rectifier diodes are available in press-fit packages and cover a current range up to 50 amps and voltage up to 1500 volts.

### Power zener diodes

The BZP and BZV series offer zener voltages of 22, 33 and 39V and currents up to 50A and are housed in press-fit packages. The press-fit package is available with different package modifications (connectors, wires, flexible cable).

### Rectifier stacks

Rectifier stacks are manufactured based on the power rectifier diodes of the BYY and BYP series. Their optimized design means they are not sensitive to overload and high temperature. Rectifier stacks are available for self, forced air and oil cooling methods.

### Back-off diodes

Again based on the BYY and BYP series of power rectifier diodes these offer a drop voltage of 0.83V per diode.

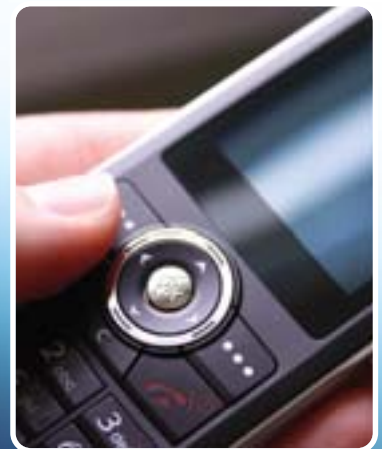

## Contents

### Schottky diodes

Schottky rectifier diodes	38
Dual Schottky diodes	38
Multiple Schottky diodes	39

### Varactor (tuner) diodes

12 volt hyperabrupt varactor diodes	39
25 volt hyperabrupt varactor diodes	40

### Power diodes

Rectifier diodes	40
Power zener diodes	40
Rectifier stacks	40
Back-off diodes	40



## Schottky diodes

Part number	$V_R$ Max	$I_F$ Max. mA	$I_{FSM}$ Max. A	$V_F$		$I_R$		$C_D$ @ $f = 1\text{MHz}$		$t_{rr}$ ns	$P_D$ W	Package
	Max. V			Max. mV	@ $I_F$ mA	Max. $\mu\text{A}$	@ $V_R$ V	Typ. pF	@ $V_R$ V			
ZLLS410	10	570	17	380	100	5	8	26	10	3	0.33	SOD323 (D1)
BAT54	30	200	0.6	500	30	4	25	7.5	1	5	0.33	SOT23 (D1)
ZLLS2000	40	2200	36	540	2000	40	30	65	30	6	1.1	SOT23-6 (D1)
ZHCS2000	40	2000	20	500	2000	300	30	50	25	5.5	1.1	SOT23-6 (D1)
ZLLS1000	40	1160	22	560	1000	20	30	26	30	4	0.625	SOT23 (D1)
ZHCS1000	40	1000	12	425	1000	100	30	25	25	12	0.5	SOT23 (D1)
BAT1000	40	1000	12	425	1000	100	30	25	25	12	0.35	SOT23 (D1)
ZHCS750	40	750	12	490	750	100	30	25	25	12	0.5	SOT23 (D1)
BAT750	40	750	12	490	750	100	30	25	25	12	0.35	SOT23 (D1)
ZLLS500	40	700	13	530	500	10	30	16	30	3	0.5	SOT23 (D1)
ZHCS500	40	500	6.75	550	500	40	30	20	25	10	0.33	SOT23 (D1)
ZLLS400	40	520	12	500	400	10	30	15	30	2.46	0.33	SOD323 (D1)
ZHCS400	40	400	6.75	500	400	40	30	20	25	10	0.25	SOD323 (D1)
ZLLS350	40	380	6	1000	275	4	30	3.5	30	1	0.36	SOD523 (D1)
ZHCS350	40	350	4.2	810	350	12	30	3.3	25	1.6	0.33	SOD523 (D1)
ZHCS1006	60	900	12	600	1000	100	45	17	25	12	0.5	SOT23 (D1)
ZHCS756	60	750	12	610	750	100	45	17	25	12	0.5	SOT23 (D1)
ZHCS506	60	500	5.5	630	500	40	45	10	25	10	0.33	SOT23 (D1)

## Dual Schottky diodes

Part number	$V_R$	$I_F$ Max. mA	$I_{FSM}$ Max. A	$V_F$		$I_R$		$C_D$ @ $f = 1\text{MHz}$		$t_{rr}$ ns	$P_D$ W	Package
	Max. V			Max. mV	@ $I_F$ mA	Max. $\mu\text{A}$	@ $V_R$ V	Typ. pF	@ $V_R$ V			
BAT54A	30	200	0.6	500	30	4	25	10	1	5	0.33	SOT23 (D2)
BAT54C	30	200	0.6	500	30	4	25	10	1	5	0.33	SOT23 (D3)
BAT54S	30	200	0.6	500	30	4	25	10	1	5	0.33	SOT23 (D)
ZXSD500E6*	40	800	13	550	500	10	30	16	30	3	1.1	SOT23-6 (D2)
ZXSDS2M832	60	1650	16.8	600	1000	100	45	17	25	12	1.2	DFN832 (D1)

\*Advance information

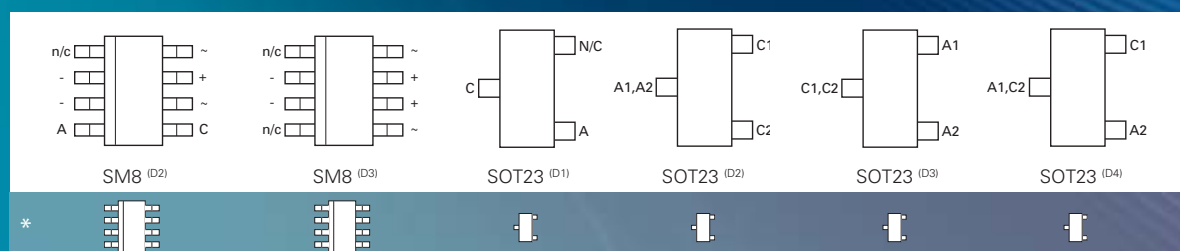

\*Indicative relative size

## Multiple Schottky diodes

Part number	$V_{RMS}$	$I_F (av)$	$I_{FSM}$	$V_F$		$I_R$		$C_D @ f = 1MHz$		$t_{rr} (typ)$ ns	$P_D$ W	Package
	Max. V	Max. A	Max. A	Max. mV	@ $I_F$ mA	Max. $\mu A$	@ $V_R$ V	Typ. pF	@ $V_R$ V			
Schottky bridge rectifier with additional free wheeling diode												
ZXSBMR16PT8	13.2	0.4	13	550	500	10	30	16	30	3	1.0	SM8 (D2)
Schottky bridge rectifier												
ZXSB1000QT8*	17	1.0	5	560	1000	20	30	26	30	4	2.0	SM8 (D3)

\*Advance information

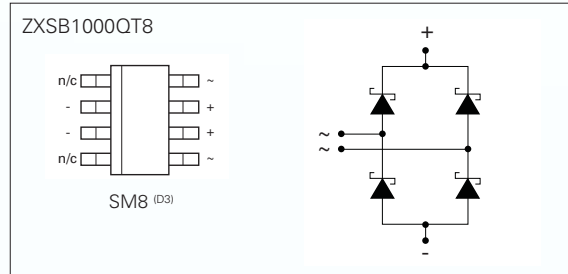
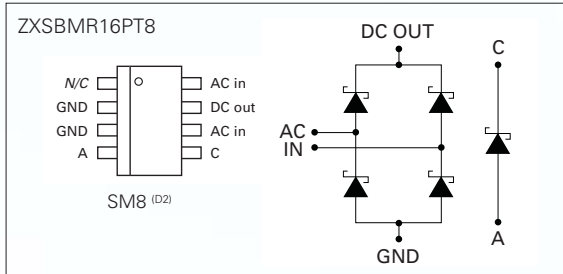

## 12 volt hyperabrupt varactor diodes

Part number	Capacitance $V_R = 1V, f = 1MHz$	Capacitance $V_R = 2.5V, f = 1MHz$		Capacitance $V_R = 4V, f = 1MHz$	$Q$ $V_R = 4V, f = 50MHz$	Package
	Min. pF	Min. pF	Max. pF	Min. pF	Min.	
ZC930	8.7	4.3	5.5	2.9	200	SOT23 (D1)
ZMV930	8.7	4.3	5.5	2.9	200	SOD323 (D1)
ZC931	13.5	6.5	7.8	4	300	SOT23 (D1)
ZMV931	13.5	6.5	7.8	4	300	SOD323 (D1)
ZC932	17	8.5	10.5	5.5	200	SOT23 (D1)
ZMV932	17	8.5	10.5	5.5	200	SOD323 (D1)
ZMV933	42	18	27	12	150	SOD323 (D1)
ZMV933A	42	20.25	24.75	12	150	SOD323 (D1)
ZC933	42	18	27	12	150	SOT23 (D1)
ZC933A	42	20.25	24.75	12	150	SOT23 (D1)
ZC934	95	40	65	25	80	SOT23 (D1)
ZC934A	95	47.25	57.75	25	80	SOT23 (D1)
ZMV934	95	40	65	25	80	SOD323 (D1)
ZMV934A	95	47.25	57.75	25	80	SOD323 (D1)

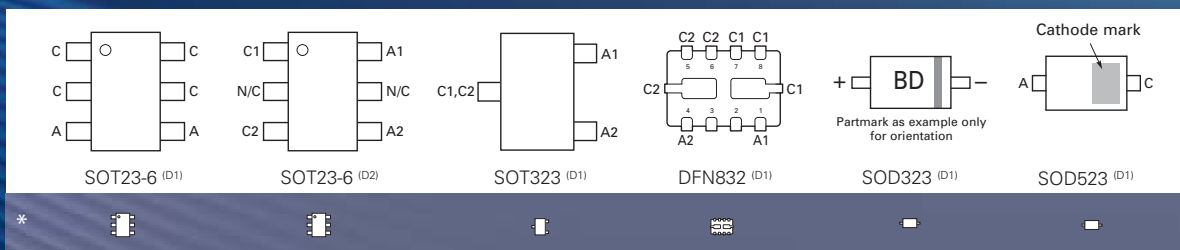

\*Indicative relative size

## 25 volt hyperabrupt varactor diodes

Part number	Capacitance $V_R = 2V, f = 1MHz$		Capacitance $C_2/C_{20}, f = 1MHz$		Q $V_R = 3V, f = 50MHz$ Min.	Package
	Min. pF	Max. pF	Min.	Max.		
ZC831B	14.25	15.75	4.5	6	300	SOT23 (D1)
ZC832B	20.9	23.1	5	6.5	200	SOT23 (D1)
ZC833B	31.35	34.65	5	6.5	200	SOT23 (D1)
ZC834B	44.65	49.35	5	6.5	200	SOT23 (D1)
ZC835B	64.6	71.4	5	6.5	100	SOT23 (D1)
ZC836B	95	105	5	6.5	100	SOT23 (D1)
ZMV832B	20.9	23.1	5	6.5	200	SOD323 (D1)
ZMV833B	31.35	34.65	5	6.5	200	SOD323 (D1)

## Rectifier diodes

Part number	$V_{RRM}$ Max. V	$I_{F(AV)}$ Max. A	$I_{FSM}$ Max. A	$V_F$		$I_R@V_{RRM}$ Max. mA	Package
				Max. V	@ $I_f$ A		
BYY57/58	75...1500	35	600	1.15	35	0.25	Hermetic press-fit
BYY57A/58A	75...800	50	900	1.15	50	0.25	Hermetic press-fit
BYP53/54	75...800	25	425	1.1	25	0.25	Press-fit with plastic cover
BYP57/58	75...800	35	600	1.1	35	0.25	Press-fit with plastic cover
BYY53/54	75...1500	25	425	1.1	25	0.25	Hermetic press-fit

## Power zener diodes

Part number	$V_Z$ Typ V	$I_{F(AV)}$ Max. A	$I_{FSM}$ Max. A	$V_F@$		$I_Z$ Max. A	Package
				Max. V	@ $I_f$ A		
BZP61/62	22 / 27 / 33 / 39	35	600	1.1	35	5.5 / 4.5 / 3.8 / 3.3	Press-fit with plastic cover
BZP63/64	22 / 27 / 33 / 39	50	700	1.1	35	6.3 / 5.2 / 4.3 / 3.8	Press-fit with plastic cover
BZV61/62	22 / 27 / 33 / 39	35	600	1.1	35	7.2 / 5.8 / 4.8 / 4.2	Hermetic press-fit
BZV63/64	22 / 27 / 33 / 39	50	700	1.1	35	8.1 / 6.6 / 5.5 / 4.8	Hermetic press-fit

## Rectifier stacks

Part number	$V_{IN}$ Max. V	$I_{d(AV)}$ Max. A	$V_{OUT}$ Max. V	Package
Rectifier stacks	1000	2400	1300	100mm x 125mm cooling plate 100mm x 250mm cooling plate 100mm x 375mm cooling plate 100mm x 500mm cooling plate

## Back-off diodes

Part number	Drop voltage Max. V	$I_{FAVM}$ Max. A	Package
Back-off diodes	0.8...33.2	25...100 <sup>(1)</sup>	100mm x 125mm cooling plate 100mm x 250mm cooling plate 100mm x 375mm cooling plate 100mm x 500mm cooling plate

(1) Higher current values are possible with parallel connecting



\*Indicative relative size



# MOSFETs

## Section 3.0

Zetex' MOSFET portfolio is comprised of N and P-channel parts, with a wide variety of voltages up to 450V for use in a broad range of end products from portable equipment to power supplies, covering automotive, consumer and industrial markets.

The diverse range of high efficiency power and signal management devices featured within this section includes parts derived from both planar and trench technology with drive capability down to 1.8V, avalanche rated devices and self-protected IntelliFET™ parts.

By utilizing the strengths of each, Zetex can provide optimized MOSFET performance appropriately tailored to specific application areas including DC-DC conversion, motor drive, audio Class D output stages, backlight inverters, active clamping, power supply start up and power line disconnect.



## Contents

<b>20V devices</b>	
N-channel	42
P-channel	42
Complementary	43
<b>30 to 50V devices</b>	
N-channel	43
P-channel	44
Complementary	44
H-bridge	44
<b>60 to 70V devices</b>	
N-channel	45
P-channel	46
Complementary	46
H-bridge	46
Self-protected IntelliFET™	47
<b>80 to 100V devices</b>	
N-channel	48
P-channel	49
H-bridge	49
<b>150 to 450V devices</b>	
N-channel	49
P-channel	50



# N-channel 20V

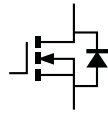

Part number	Polarity	BV <sub>DSS</sub> V	I <sub>D</sub> A	P <sub>D</sub> W	R <sub>DS(on)</sub> max. @				C <sub>iss</sub> typ.@ V <sub>DS</sub> =10V pF	Q <sub>g</sub> typ.@ V <sub>GS</sub> =4.5V nC	Package
					V <sub>GS</sub> =1.8V Ω	V <sub>GS</sub> =2.5V Ω	V <sub>GS</sub> =2.7V Ω	V <sub>GS</sub> =4.5V Ω			
ZXMN2A04DN8	2 x N	20	7.7	2.1		0.04	-	0.025	1880	40.5	SO8 (M2)
ZXMN2A02X8	N	20	7.6	1.8		0.04	-	0.02	2050	18.9	MSOP8 (M1)
ZXM64N02X	N	20	5.4	1.8		-	0.05	0.04	1100	12.5	MSOP8 (M1)
ZXMN2A03E6	N	20	4.6	1.7		0.1	-	0.055	837	8.2	SOT23-6 (M1)
ZXMN2B03E6	N	20	4.3	1.1	0.075	0.055		0.04	1160	1.5	SOT23-6 (M1)
ZXMN2A14F	N	20	4.1	1		0.11	-	0.06	544	6.6	SOT23 (M1)
ZXMN2F30FH	N	20	3.6	1	-	0.065	-	0.045	330	5.8	SOT23 (M1)
ZXMN2B14FH	N	20	3.5	1	0.1	0.075		0.055	872	11	SOT23 (M1)
ZXMN2F34FH	N	20	3.0	1	-	0.120	-	0.060	641		SOT23 (M1)
ZXMN2F34MA	N	20	5.1	2.2	-	0.12	-	0.06	277	2.8	DFN322
ZXM62N02E6	N	20	3.2	1.7		-	0.125	0.1	480	5	SOT23-6 (M1)
ZXMN2A01E6	N	20	3	1.7		0.225	-	0.12	299	3.1	SOT23-6 (M1)
ZXMN2AM832	2 x N	20	3	1.5		0.225	-	0.12	310	3.1	DFN832 (M1)
ZXMD63N02X	2 x N	20	2.4	1.25		-	0.15	0.13	360	4.8	MSOP8 (M2)
ZXMN20866DE6	2 x N	20	1.8	1.5	0.5	0.4	-	0.3	230	3.0	SOT23 (M2)
ZXMN2B01F	2 x N	20	1.8	1.5	-	0.15		0.1	230	3	SOT23 (M2)
ZXMN2A01F	N	20	2	0.8		0.225	-	0.12	310	3	SOT23 (M1)
ZXM61N02F	N	20	1.7	0.8		-	0.24	0.18	170	2.6	SOT23 (M1)

# P-channel 20V

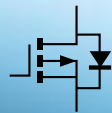

Part number	Polarity	BV <sub>DSS</sub> V	I <sub>D</sub> A	P <sub>D</sub> W	R <sub>DS(on)</sub> max. @			C <sub>iss</sub> typ. @ V <sub>DS</sub> = -10V pF	Q <sub>g</sub> typ. @ V <sub>GS</sub> = -4.5V nC	Package
					V <sub>GS</sub> = -2.5V Ω	V <sub>GS</sub> = -2.7V Ω	V <sub>GS</sub> = -4.5V Ω			
ZXM64P02X	P	-20	-3.5	1.8	-	0.13	0.09	950	5	MSOP8 (M1)
ZXM62P02E6	P	-20	-2.3	1.7	-	0.375	0.2	340	4.6	SOT23-6 (M1)
ZXMD63P02X	2 x P	-20	-1.7	1.25	-	0.4	0.27	300	4.1	MSOP8 (M2)
ZXM61P02F	P	-20	-0.9	0.8	-	0.9	0.6	160	2.7	SOT23 (M1)

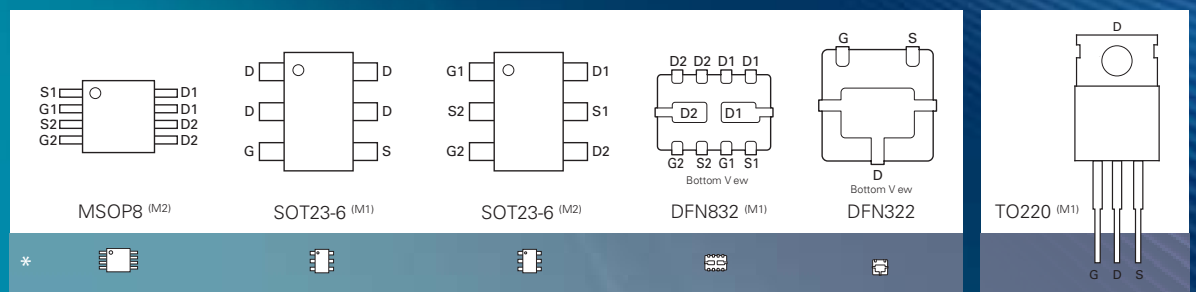
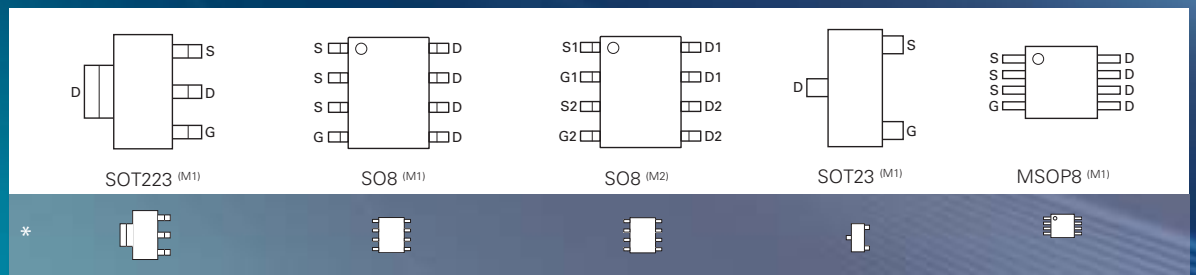

\*Indicative relative size

## Complementary 20V

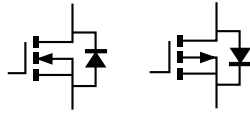

Part number	Polarity	BV <sub>DSS</sub> V	I <sub>D</sub> A	P <sub>D</sub> W	R <sub>DS(on)</sub> max. @		C <sub>iss</sub> typ. @ V <sub>DS</sub> = 10V pF	Q <sub>g</sub> typ. @ V <sub>GS</sub> = 4.5V nC	Package
					V <sub>GS</sub> = 2.7V Ω	V <sub>GS</sub> = 4.5V Ω			
ZXMD63C02X	N + P	20 -20	2.4 -1.7	1.25	0.15 0.4	0.13 0.27	360 300	4.8 4.1	MSOP8 (M3)

## N-channel from 30 to 50V

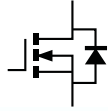

Part number	Polarity	BV <sub>DSS</sub> V	I <sub>D</sub> A	P <sub>D</sub> W	R <sub>DS(on)</sub> max. @				C <sub>iss</sub> typ. @ V <sub>DS</sub> = 15V pF	Q <sub>g</sub> typ. @ V <sub>GS</sub> = 4.5V nC	Q <sub>g</sub> typ. @ V <sub>GS</sub> = 10V nC	Package
					V <sub>GS</sub> = 2.5V Ω	V <sub>GS</sub> = 4.5V Ω	V <sub>GS</sub> = 5V Ω	V <sub>GS</sub> = 10V Ω				
ZXMN3A04K	N	30	18.4	10.1	-	0.03	-	0.02	1890	-	36.8	DPAK (M1)
ZXMN3A04DN8	2 × N	30	8.5	2.1	-	0.03	-	0.02	1890	36.8	-	SO8 (M2)
ZXMN3F31DN8	2 × N	30	7.0	2.1	-	0.046	-	0.024	742	-	16.4	SO8 (M2)
ZXMN3F318DN8*	2 × N	30	7.0 6.0	2.1	- -	0.046 0.055	- -	0.024 0.035	742 -	- -	16.4 8.8	SO8 (M2)
ZXMN3A02X8	N	30	6.7	1.8	-	0.035	-	0.025	1400	-	26.8	MSOP8 (M1)
ZXMN3A06DN8	2 × N	30	6.2	2.1	-	0.05	-	0.035	750	-	17.5	SO8 (M2)
ZXMN3G32DN8	2 × N	30	6.0	2.1	-	0.042	-	0.028	740	-	6.5	SO8 (M2)
ZXM62N03G	N	30	4.7	3.9	-	0.15	-	0.11	380	-	9.6	SOT223 (M1)
ZXMN3A03E6	N	30	4.6	1.7	-	0.065	-	0.05	600	-	12.6	SOT23-6 (M1)
ZXMN3F30FH	N	30	4.0	1	-	0.065	-	0.047	305	-	9.1	SOT23 (M1)
ZXMN3A14F	N	30	3.9	1	-	0.095	-	0.065	448	-	8.6	SOT23 (M1)
ZXMN3B14F	N	30	3.5	1	0.14	0.08	-	-	568	-	6.7	SOT23 (M1)
ZXMN3A01E6	N	30	3	1.7	-	0.18	-	0.12	190	-	3.9	SOT23-6 (M1)
ZXMN3AM832	2 × N	30	3	1.5	-	0.18	-	0.12	190	-	3.9	DFN832 (M1)
ZXMD63N03X	2 × N	30	2.3	1.25	-	0.2	-	0.135	300	-	6.1	MSOP8 (M2)
ZXMN3A01F	N	30	2	0.625	-	0.18	-	0.12	190	-	3.9	SOT23 (M1)
ZXMN3B01F	N	30	2	0.625	0.24	0.15	-	-	258	-	2.9	SOT23 (M1)
ZXM61N03F	N	30	1.4	0.625	-	0.3	-	0.22	160	-	3.2	SOT23 (M1)
ZXM64N035L3	N	35	13	20	-	0.07	-	0.06	970	-	22	TO220 (M1)
ZXMN4A06K	N	40	10.9	9.5	-	0.075	-	0.05	810	-	17.1	DPAK (M1)
ZXMN4A06G	N	40	7	3.9	-	0.075	-	0.05	810	-	18.2	SOT223 (M1)
BSS138	N	50	0.2	0.36	-	-	3.5	-	35	-	-	SOT23 (M1)

\*Advance information

## P-channel from 30 to 50V

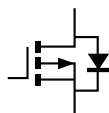

Part number	Polarity	BV <sub>DSS</sub> V	I <sub>D</sub> A	P <sub>D</sub> W	R <sub>DS(on)</sub> max. @			C <sub>iss</sub> typ. @ V <sub>DS</sub> = 15V pF	Q <sub>g</sub> typ. @ V <sub>GS</sub> = 10V nC	Package
					V <sub>GS</sub> = -4.5V Ω	V <sub>GS</sub> = -5V Ω	V <sub>GS</sub> = -10V Ω			
ZXMP3G35N8*	P	-30	-14.0	2.5	0.018	-	0.0125	3625	55.0	SO8 (M1)
ZXMP3F36N8*	P	-30	-10.0	2.5	0.028	-	0.020	2530	41.0	SO8 (M1)
ZXMP3A16G	P	-30	-7.5	2	0.07	-	0.045	970	24.9	SOT223 (M1)
ZXMP3F37DN8*	2 x P	-30	-7.1	2.1	0.041	-	0.025	1550	31.0	SO8 (M2)
ZXMP3A16N8	P	-30	-6.7	2.5	0.07	-	0.04	970	24.9	SO8 (M1)
ZXMP3A16DN8	2 x P	-30	-5.5	2.1	0.07	-	0.045	970	24.9	SO8 (M2)
ZXMP3A17DN8	2 x P	-30	-4.4	2.1	0.11	-	0.07	630	15.8	SO8 (M2)
ZXM62P03G	P	-30	-4	3.9	0.23	-	0.15	330	10.2	SOT223 (M1)
ZXMP3A17E6	P	-30	-4	1.7	0.11	-	0.07	630	15.8	SOT23-6 (M1)
ZXM64P03X	P	-30	-3.8	1.8	0.1	-	0.075	875	37	MSOP8 (M1)
ZXMP3F30FH*	P	-30	-3.0	1	0.130	-	0.078	565	8.8	SOT23 (M1)
ZXM62P03E6	P	-30	-2.6	1.7	0.23	-	0.15	350	8	SOT23-6 (M1)
ZXMD63P03X	2 x P	-30	-2	1.25	0.27	-	0.185	280	5.4	MSOP8 (M2)
ZXMP3A13F	P	-30	-1.6	0.8	0.33	-	0.21	204	5.2	SOT23 (M1)
ZXM61P03F	P	-30	1	0.8	0.55	-	0.35	145	3.7	SOT23 (M1)
ZXM64P035L3	P	-35	-12	20	0.105	-	0.075	875	37	TO220 (M1)
ZXMP4A16K	P	-40	-9.9	9.5	0.1	-	0.06	1000	29.6	DPAK (M1)
ZXMP4A16G	P	-40	-6.4	3.9	0.1	-	0.06	1010	26.1	SOT223 (M1)
BS250P	P	-45	-0.23	0.7	-	-	14	60	1.6	E-Line (M1)
BS250F	P	-45	-0.09	0.33	-	-	14	30	0.75	SOT23 (M1)
ZVP4105A	P	-50	-0.18	0.625	-	10	-	-	-	E-Line (M1)
BSS84	P	-50	-0.13	0.36	-	10	-	-	-	SOT23 (M1)

\* Advance information

## Complementary 30 to 40V



Part number	Polarity	BV <sub>DSS</sub> V	I <sub>D</sub> A	P <sub>D</sub> W	R <sub>DS(on)</sub> max. @		C <sub>iss</sub> typ. @ V <sub>DS</sub> = 15V pF	Q <sub>g</sub> typ. @ V <sub>GS</sub> = 10V nC	Package
					V <sub>GS</sub> = 4.5V Ω	V <sub>GS</sub> = 10V Ω			
ZXMC3F31DN8*	N + P	30 -30	7.0 -4.5	2.1	0.046 0.080	0.024 0.046	742 820	16.4 15.2	SO8 (M3)
ZXMC3A17DN8	N + P	30 -30	5.4 -4.4	2.1	0.065 0.11	0.05 0.07	600 630	12.2 15.8	SO8 (M3)
ZXMC3AM832	N + P	30 -30	3.7 -2.7	1.5	0.18 0.33	0.12 0.21	190 204	3.9 5.2	DFN832 (M2)
ZXMD63C03X	N + P	30 -30	2.3 -2	1.25	0.2 0.27	0.135 0.185	300 280	6.1 5.4	MSOP8 (M3)
ZXMC4A16DN8	N + P	40 -40	5.2 -4.7	2.1	0.075 0.1	0.05 0.06	800 1010	17 26	SO8 (M3)

\* Advance information

## H-bridge 30V

Part number	Polarity	BV <sub>DSS</sub> V	I <sub>D</sub> A	P <sub>D</sub> W	R <sub>DS(on)</sub> max. @		C <sub>iss</sub> typ. @ V <sub>DS</sub> = 15V pF	Q <sub>g</sub> typ. @ V <sub>GS</sub> = 10V nC	Package
					V <sub>GS</sub> = 4.5V Ω	V <sub>GS</sub> = 10V Ω			
ZXMHC3A01T8	2 x N 2 x P	30 -30	3.1 -2.3	1.7	0.18 0.33	0.12 0.21	190 204	3.9 5.2	SM8 (M1)

# N-channel from 60 to 70V

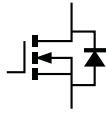

Part number	Polarity	BV <sub>DSS</sub> V	I <sub>D</sub> A	P <sub>D</sub> W	R <sub>DS(on)</sub> max. @			C <sub>iss</sub> typ.@ V <sub>DS</sub> = 30V pF	Q <sub>g</sub> typ.@ V <sub>GS</sub> = 10V nC	Package
					V <sub>GS</sub> = 4.5V Ω	V <sub>GS</sub> = 5V Ω	V <sub>GS</sub> = 10V Ω			
ZXMN6A09K	N	60	11.2	10.1	0.06	-	0.04	1426	29	DPAK (M1)
ZXMN6A25K	N	60	7	4.2	0.07	-	0.05	1063	20.4	DPAK (M1)
ZXMN6A09G	N	60	5.1	3.8	0.06	-	0.04	1410	24	SOT223 (M1)
ZXMN6A09DN8	2 x N	60	5.1	2.1	0.06	-	0.04	1410	24	SO8 (M2)
ZXMN6A25N8*	N	60	5.7	2.5	0.07	-	0.05	1063	20.4	SO8 (M1)
ZXMN6A25G	N	60	4.8	2	0.07	-	0.05	1063	20.4	SOT223 (M1)
ZXMN6A25DN8	2 x N	60	4.7	2.1	0.07	-	0.05	1063	20.4	SO8 (M2)
ZXMN6A08G	N	60	3.8	3.9	0.15	-	0.08	470	5.8	SOT223 (M1)
ZXMN6A11G	N	60	3.8	3.9	0.18	-	0.12	330	5.7	SOT223 (M1)
ZXMN6A11Z	N	60	3.2	1.5	0.18	-	0.12	330	5.7	SOT89 (M1)
ZXMN6A08E6	N	60	3.1	1.7	0.15	-	0.08	459	5.8	SOT23-6 (M1)
ZXMN6A11DN8	2 x N	60	2.7	2.1	0.18	20.4	0.12	330	5.7	SO8 (M2)
ZXMN6A07Z	N	60	2.2	1.5	0.35	-	0.25	166	3.2	SOT89 (M1)
ZVN4306G	N	60	2.1	3	-	0.45	0.33	220	5.2	SOT223 (M1)
ZVN4306GV*	N	60	2.1	3	-	0.45	0.33	220	5.2	SOT223 (M1)
ZXMN6A07F	N	60	1.2	0.8	0.35	-	0.25	166	3.2	SOT23 (M1)
ZVN4306A	N	60	1.1	1.1	-	0.45	0.33	220	5.2	E-Line (M1)
ZVN4306AV†	N	60	1.1	1.1	-	0.45	0.33	220	5.2	E-Line (M1)
ZVN4206G	N	60	1	2	-	1.5	1	70	2.4	SOT223 (M1)
ZVN4206GV†	N	60	1	2	-	1.5	1	70	2.4	SOT223 (M1)
ZVN2106G	N	60	0.71	2	-	-	2	50	1.6	SOT223 (M1)
ZVN4206A	N	60	0.6	0.7	-	1.5	1	70	2.4	E-Line (M1)
ZVN4206AV†	N	60	0.6	0.7	-	1.5	1	70	2.4	E-Line (M1)
ZVN2106A	N	60	0.45	0.7	-	-	2	50	1.6	E-Line (M1)
VN10LP	N	60	0.27	0.625	-	7.5	5	30	0.95	E-Line (M1)
ZVN3306A	N	60	0.27	0.625	-	-	5	30	0.95	E-Line (M1)
ZVN4106F	N	60	0.2	0.33	-	5	2.5	27	1	SOT23 (M1)
ZVN3306F	N	60	0.15	0.33	-	-	5	30	0.95	SOT23 (M1)
2N7002	N	60	0.115	0.33	-	-	3.75	27	1	SOT23 (M1)
ZXMN7A11K	N	70	6.1	8.5	0.19	-	0.13	300	7.4	DPAK (M1)
ZXMN7A11G	N	70	3.8	3.9	0.19	-	0.13	300	7.4	SOT223 (M1)

†Avalanche rated product \*Advance information

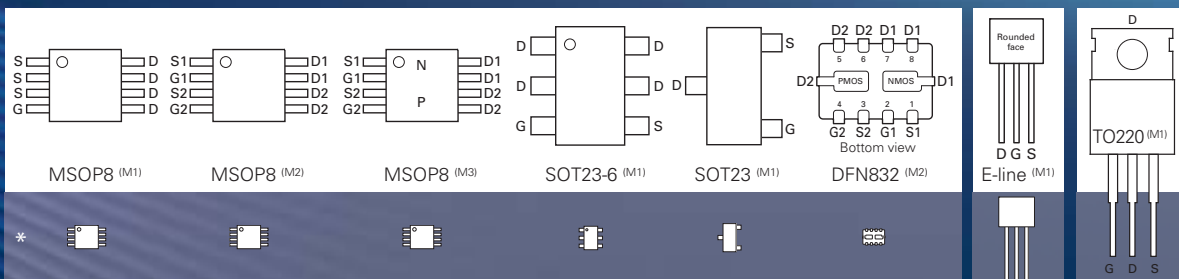
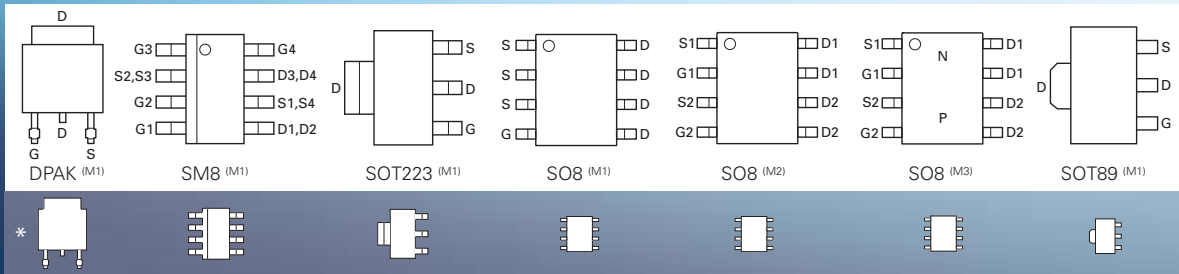

\*Indicative relative size

## P-channel from 60 to 70V

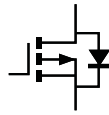

Part number	Polarity	BV <sub>DSS</sub> V	I <sub>D</sub> A	P <sub>D</sub> W	R <sub>DS(on)</sub> max. @		C <sub>iss</sub> typ.@ V <sub>DS</sub> = -30V pF	Q <sub>g</sub> typ.@ V <sub>GS</sub> = -10V nC	Package
					V <sub>GS</sub> = -4.5V Ω	V <sub>GS</sub> = -10V Ω			
ZXMP6A18K	P	-60	-10.4	10.1	0.08	0.055	1580	44	DPAK (M1)
ZXMP6A16K	P	-60	-5.4	4.24	0.13	0.085	1021	24.2	DPAK (M1)
ZXMP6A18DN8	2 x P	-60	-4.8	2.1	0.08	0.055	1580	44	SO8 (M2)
ZXMP6A17G	P	-60	-4.1	3.9	0.19	0.125	637	17.7	SOT223 (M1)
ZXMP6A16DN8	2 x P	-60	-3.9	2.1	0.125	0.085	1021	24.2	SO8 (M2)
ZXMP6A17DN8	2 x P	-60	-3.2	2.1	0.19	0.125	637	17.7	SO8 (M2)
ZXMP6A17E6	P	-60	-3	1.7	0.19	0.125	637	17.7	SOT23-6 (M1)
ZXMP6A13G	P	-60	-2.3	3.9	0.595	0.39	233	5.1	SOT223 (M1)
ZXMP6A13F	P	-60	-1.1	0.8	0.6	0.4	233	5.1	SOT23 (M1)
ZVP2106G	P	-60	-0.45	2	-	5	55	1.7	SOT223 (M1)
ZVP2106A	P	-60	-0.28	0.7	-	5	55	1.7	E-Line (M1)
ZVP3306A	P	-60	-0.16	0.625	-	14	27	0.9	E-Line (M1)
ZVP3306F	P	-60	-0.09	0.33	-	14	27	0.9	SOT23 (M1)
ZXMP7A17K	P	-70	-5.7	9.25	0.25	0.16	650	18	DPAK (M1)
ZXMP7A17G	P	-70	-3.7	3.9	0.25	0.16	650	18	SOT223 (M1)

## Complementary 60V

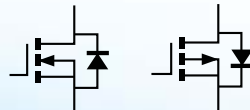

Part number	Polarity	BV <sub>DSS</sub> V	I <sub>D</sub> A	P <sub>D</sub> W	R <sub>DS(on)</sub> max. @		C <sub>iss</sub> typ.@ V <sub>DS</sub> = 30V pF	Q <sub>g</sub> typ.@ V <sub>GS</sub> = 10V nC	Package
					V <sub>GS</sub> = 4.5V Ω	V <sub>GS</sub> = 10V Ω			
ZXMC6A09DN8	N + P	60 -60	5.1 -4.8	2.1	0.06 0.08	0.04 0.055	1410 1580	24 44	SO8 (M3)
ZXMC4559DN8	N + P	60 -60	4.7 -3.9	2.1	0.075 0.125	0.055 0.085	1063 1021	20.4 24.2	SO8 (M3)

## H-bridge 60V

Part number	Polarity	BV <sub>DSS</sub> V	I <sub>D</sub> A	P <sub>D</sub> W	R <sub>DS(on)</sub> max. @		C <sub>iss</sub> typ.@ V <sub>DS</sub> = 30V pF	Q <sub>g</sub> typ.@ V <sub>GS</sub> = 10V nC	Package
					V <sub>GS</sub> = 4.5V Ω	V <sub>GS</sub> = 10V Ω			
ZXMHC6A07T8	2 x N 2 x P	60 -60	1.8 -1.5	1.7	0.35 0.63	0.25 0.425	166 233	3.2 5.1	SM8 (M1)
ZXMHN6A07T8	4 x N	60	1.6	1.25	0.35	0.25	166	3.2	SM8 (M2)

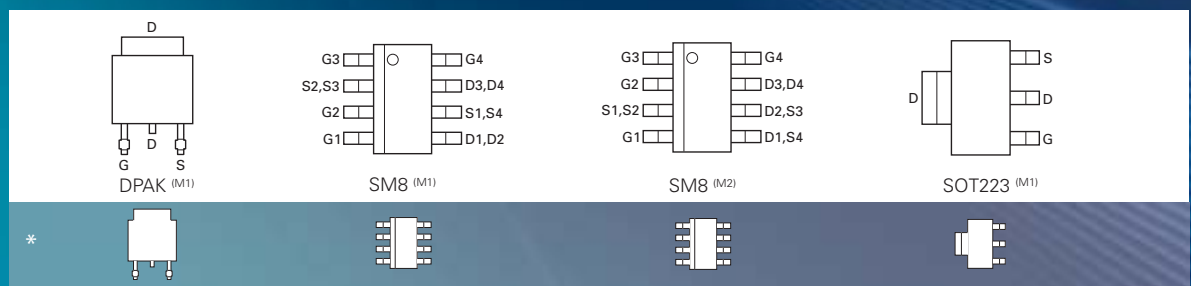

\* Indicative relative size

# 60V N-channel self-protected IntelliFET™

Part number	Additional Function	TAB	BV <sub>DSS</sub> V	I <sub>D</sub> V <sub>IN</sub> = 5V A	P <sub>D</sub> W	R <sub>DS(on)</sub> max. @			V <sub>DS(S/C)</sub> <sup>(1)</sup> V <sub>IN</sub> = 5V V	E <sub>AS</sub> <sup>(2)</sup> mJ	T <sub>JT</sub> <sup>(3)</sup> °C	Package
						V <sub>IN</sub> = 3V mΩ	V <sub>IN</sub> = 5V mΩ	V <sub>IN</sub> = 10V mΩ				
BSP75G	Improved power dissipation	D	60	1.4	2.5	–	675	550	36	550	150	SOT223 (M2)
ZXMS6002G	with status flag	D	60	1.4	2.5	–	675	550	36	550	150	SOT223 (M3)
ZXMS6003G	with status and programmable current limit	D	60	1.4	2.5	–	675	550	36	550	150	SOT223 (M3)
ZXMS6005G*	BSP75N pin out	S	60	1.3	1.5	600	500	–	36	550	150	SOT223 (M4)
ZXMS6004FF*	High power SOT23	–	60	1.3	1.5	600	500	–	36	550	150	SOT23F
BSP75N	BSP75N pin out	S	60	1.2	1.5	–	675	550	36	550	150	SOT223 (M4)
ZXMS6001G	500μA input current	S	60	1.1	1.5	2000	675	–	36	550	150	SOT223 (M4)

\*Advance information

- (1) Maximum drain source voltage during short circuit conditions
- (2) Unclamped single pulse inductive energy absorption
- (3) Thermal overload trip temperature

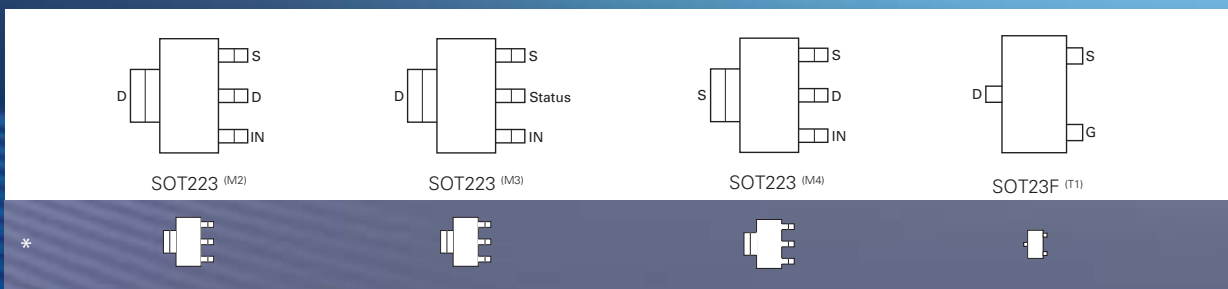

\*Indicative relative size

# N-channel from 80 to 100V

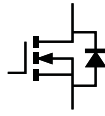

Part number	Polarity	BV <sub>DSS</sub>	I <sub>D</sub>	P <sub>D</sub>	R <sub>DS(on)</sub> max. @					C <sub>iss</sub> typ.@		Q <sub>g</sub> typ.@	Package
					V <sub>GS</sub> =3V	V <sub>GS</sub> =4.5V	V <sub>GS</sub> =5V	V <sub>GS</sub> =6V	V <sub>GS</sub> =10V	V <sub>DS</sub> =50V	V <sub>GS</sub> =10V		
		V	A	W	Ω	Ω	Ω	Ω	Ω	pF	nC		
ZXMN10A09K	N	100	7.7	10.1	-	-	-	0.1	0.085	1313	26	DPAK (M1)	
ZXMN10A25K	N	100	4.2	4.2	-	-	-	0.15	0.125	859	17	DPAK (M1)	
ZXMN10A25G	N	100	2.9	2	-	-	-	0.15	0.125	859	17	SOT223 (M1)	
ZXMN10A11K	N	100	2.4	4	-	-	-	0.45	0.35	274	5.4	DPAK (M1)	
ZXMN10A11G	N	100	2.4	3.9	-	-	-	0.45	0.35	274	5.4	SOT223 (M1)	
ZXMN10A08DN8	2 x N	100	2.1	1.8	-	-	-	0.3	0.25	405	7.7	SO8 (M2)	
ZXMN10A08G	N	100	2	2	-	-	-	0.3	0.25	405	7.7	SOT223 (M1)	
ZXMN10A08E6	N	100	1.9	1.7	-	-	-	0.3	0.25	405	7.7	SOT23-6 (M1)	
ZXMN10B08E6	N	100	1.9	1.7	-	0.3	-	-	0.23	497	9.2	SOT23-6 (M1)	
ZVN4310G	N	100	1.67	3	-	-	0.75	-	0.54	200	6	SOT223 (M1)	
ZXMN10A07Z	N	100	1.4	1.5	-	-	-	0.9	0.7	138	2.9	SOT89 (M1)	
ZVN4310A	N	100	0.9	1.1	-	-	0.65	-	0.5	200	6	E-Line (M1)	
ZVN4210G	N	100	0.8	2	-	-	1.8	-	1.5	65	2.7	SOT223 (M1)	
ZXMN10A07F	N	100	0.8	0.8	-	-	-	0.9	0.7	138	2.9	SOT23 (M1)	
ZVNL110G	N	100	0.6	2	-	-	4.5	-	3	60	1.8	SOT223 (M1)	
ZVN2110G	N	100	0.5	2	-	-	-	-	4	60	1.8	SOT223 (M1)	
ZVN4210A	N	100	0.45	0.7	-	-	1.8	-	1.5	65	2.7	E-Line (M1)	
ZVN2110A	N	100	0.32	0.7	-	-	-	-	4	60	1.8	E-Line (M1)	
ZVNL110A	N	100	0.32	0.7	-	-	4.5	-	3	60	1.8	E-Line (M1)	
ZVN3310A	N	100	0.2	0.625	-	-	-	-	10	25	0.7	E-Line (M1)	
BSS123	N	100	0.17	0.36	-	-	-	-	6	25	0.7	SOT23 (M1)	
BSS123A	N	100	0.17	0.36	-	10	-	-	6	40	1.2	SOT23 (M1)	
ZXM41N10F	N	100	0.17	0.36	12	8	-	-	-	25	1.2	SOT23 (M1)	
ZVN3310F	N	100	0.1	0.33	-	-	-	-	10	25	0.7	SOT23 (M1)	

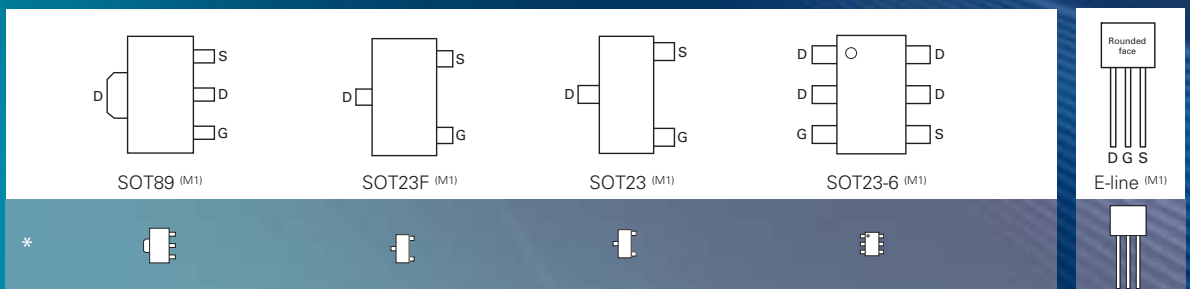
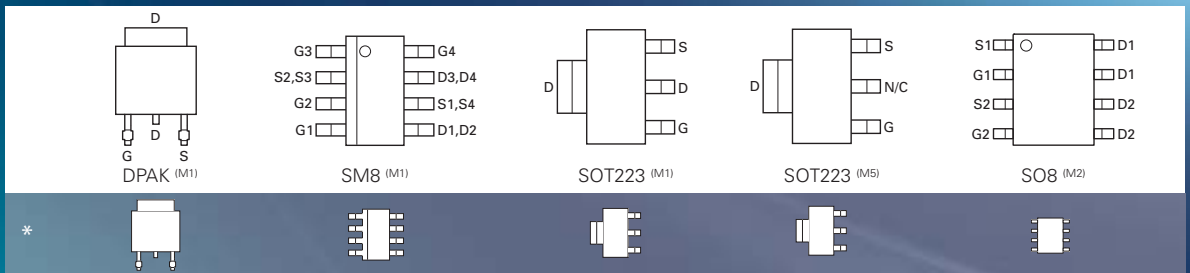

\*Indicative relative size



## P-channel from 80 to 100V

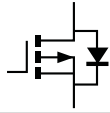

Part number	Polarity	BV <sub>DSS</sub> V	I <sub>b</sub> A	P <sub>D</sub> W	R <sub>DS(on)</sub> max. @		C <sub>iss</sub> typ.@ V <sub>DS</sub> = -50V pF	Q <sub>g</sub> typ.@ V <sub>GS</sub> = -10V nC	Package
					V <sub>GS</sub> = -6V Ω	V <sub>GS</sub> = -10V Ω			
ZXMP10A18K	P	-100	-3.8	4.3	0.19	0.15	1055	27	DPAK (M1)
ZXMP10A18G	P	-100	-3.7	3.9	0.19	0.15	1055	26.9	SOT223 (M1)
ZXMP10A16K	P	-100	-3	4.24	0.29	0.235	717	16.5	DPAK (M1)
ZXMP10A17K	P	-100	-3.9	4.3	0.450	0.350	424	10.7	DPAK (M1)
ZXMP10A17E6	P	-100	-1.6	1.7	0.45	0.35	424	10.7	SOT23-6 (M1)
ZXMP10A13F	P	-100	-0.7	0.8	1.45	1	141	3.5	SOT23 (M1)
ZVP2110G	P	-100	-0.31	2	-	8	58	1.8	SOT223 (M1)
ZVP2110A	P	-100	-0.14	0.7	-	8	58	1.8	E-Line (M1)
ZVP3310A	P	-100	-0.14	0.625	-	20	20	0.7	E-Line (M1)
ZVP3310F	P	-100	-0.075	0.33	-	20	20	0.7	SOT23 (M1)

## H-bridge from 80 to 100V

Part number	Polarity	BV <sub>DSS</sub> V	I <sub>b</sub> A	P <sub>D</sub> W	R <sub>DS(on)</sub> max. @		C <sub>iss</sub> typ.@ V <sub>DS</sub> = 60V pF	Q <sub>g</sub> typ.@ V <sub>GS</sub> = 10V nC	Package
					V <sub>GS</sub> = 6V Ω	V <sub>GS</sub> = 10V Ω			
ZXMHC10A07T8	2 x N 2 x P	100 -100	1.4 -1.3	1.3	0.9 1.45	0.7 1	138 141	2.9 3.5	SM8 (M1)

## N-channel from 150 to 450V

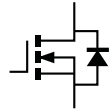

Part number	Polarity	BV <sub>DSS</sub> V	I <sub>b</sub> A	P <sub>D</sub> W	R <sub>DS(on)</sub> max. @						C <sub>iss</sub> typ. @ V <sub>DS</sub> =50V pF	Q <sub>g</sub> typ. @ V <sub>GS</sub> =10V nC	Package
					V <sub>GS</sub> =2.4V Ω	V <sub>GS</sub> =2.5V Ω	V <sub>GS</sub> =2.6V Ω	V <sub>GS</sub> =3V Ω	V <sub>GS</sub> =5V Ω	V <sub>GS</sub> =10V Ω			
ZVN2120G	N	200	0.32	2	-	-	-	-	-	10	58	2.2	SOT223 (M1)
ZVNL120G	N	200	0.32	2	-	-	-	10	10	-	58	2.2	SOT223 (M1)
ZVN2120A	N	200	0.18	0.7	-	-	-	-	-	10	58	2.2	E-Line (M1)
ZVNL120A	N	200	0.18	0.7	-	-	-	10	10	-	58	2.2	E-Line (M1)
BS107P	N	200	0.12	0.5	-	-	23	-	30	-	58	2.7	E-Line (M1)
ZVN3320A	N	200	0.1	0.625	-	-	-	-	-	25	-	-	E-Line (M1)
ZVN3320F	N	200	0.06	0.33	-	-	-	-	-	25	-	-	SOT23 (M1)
ZVN4424G	N	240	0.5	2.5	-	6	-	-	-	5.5	100	18	SOT223 (M1)
ZVN4424A	N	240	0.26	0.75	-	6	-	-	-	5.5	100	18	E-Line (M1)
ZVN4424Z	N	240	0.26	0.75	-	6	-	-	-	5.5	100	18	SOT89 (M1)
ZVN0124A	N	240	0.16	0.7	-	-	-	-	-	16	62	1.4	E-Line (M1)
ZVN4525G	N	250	0.31	2	9.5	-	-	-	-	8.5	72	2.5	SOT223 (M1)
ZVN4525Z	N	250	0.24	1.2	9.5	-	-	-	-	8.5	72	2.5	SOT89 (M1)
ZVN4525E6	N	250	0.23	1.1	9.5	-	-	-	-	8.5	72	2.5	SOT23-6 (M1)
ZVN0545G	N	450	0.14	2	-	-	-	-	-	50	55	-	SOT223 (M1)
ZXMN0545G4	N	450	0.14	2	-	-	-	-	-	50	55	-	SOT223 (M5)
ZXMN0545FF	N	450	0.09	1.5	-	-	-	-	-	50	55	-	SOT23F (M1)
ZVN0545A	N	450	0.09	0.7	-	-	-	-	-	50	55	-	E-Line (M1)

# P-channel from 150 to 450V

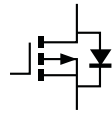

Part number	Polarity	BV <sub>DSS</sub> V	I <sub>D</sub> A	P <sub>D</sub> W	R <sub>DS(on)</sub> max. @		C <sub>iss</sub> typ. @ V <sub>DS</sub> = -50V pF	Q <sub>g</sub> typ. @ V <sub>GS</sub> = -10V nC	Package
					V <sub>GS</sub> = -3.5V Ω	V <sub>GS</sub> = -10V Ω			
ZVP2120G	P	-200	-0.3	2	-	25	65	1.6	SOT223 (M1)
ZXMP2120G4	P	-200	-0.3	2	-	25	65	1.6	SOT223 (M5)
ZXMP2120FF	P	-200	-0.137	1	-	28	65	1.6	SOT23F (M1)
ZXMP2120E5	P	-200	-0.122	0.75	-	28	65	1.6	SOT23-5 (M1)
ZVP2120A	P	-200	-0.12	0.7	-	25	65	1.6	E-Line (M1)
ZVP1320F	P	-200	-0.035	0.33	-	80	28	2	SOT23 (M1)
ZVP4424G	P	-240	-0.48	2.5	11	9	100	3.7	SOT223 (M1)
ZVP4424Z	P	-240	-0.2	1	11	9	100	3.7	SOT89 (M1)
ZVP4424A	P	-240	-0.2	0.75	11	9	100	3.7	E-Line (M1)
ZVP4525G	P	-250	-0.265	2	18	14	75	2.5	SOT223 (M1)
ZVP4525Z	P	-250	-0.205	1.2	18	14	75	2.5	SOT89 (M1)
ZVP4525E6	P	-250	-0.197	1.1	18	14	75	2.5	SOT23-6 (M1)
ZVP0545G	P	-450	-0.075	2	-	150	-	-	SOT223 (M1)
ZVP0545A	P	-450	-0.045	0.7	-	150	-	-	E-Line (M1)

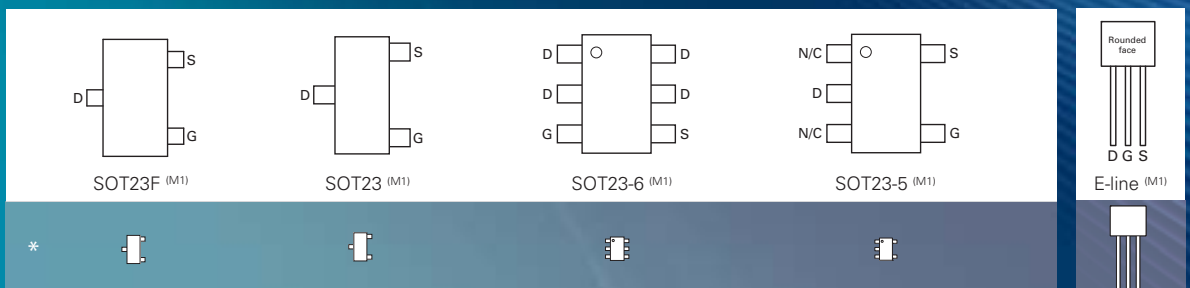
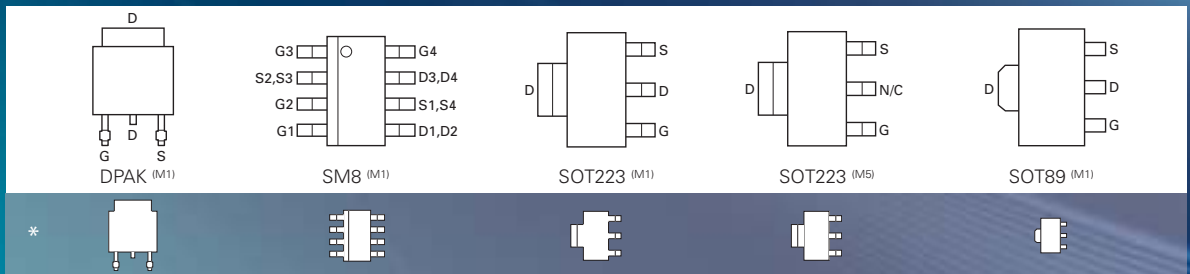

\*Indicative relative size





# Current monitors

## Section 4.0

The increasing need to make more intelligent power management decisions requires accurate and reliable current monitoring. Dedicated current monitoring ICs from Zetex provide the reporting and protection functions to suit a range of power management applications.

Two output formats are offered: a versatile current output and a voltage output for greater simplicity and accuracy.

### Contents

Current output current monitors	54
Voltage output current monitors	56



# Current output current monitors

ZXCT current monitors with a current output convert a high-side current measurement to a ground referred current output, thereby greatly simplifying high-sided current measurements. The devices enable gain to be set by a single external resistor.

The common-mode voltage of the monitored current can be substantially increased by the

addition of 1 or 2 transistors (see AN45 for more information).

## Features

- High-side current sensing
- Output voltage scaling
- Up to 2.5V sense voltage
- 2.5V - 20V supply range
- 1% typical accuracy

## Applications

- Over-current monitor
- Battery chargers
- Battery gauges
- Power management
- DC motor control

Part number	Description	V <sub>IN</sub> V	Accuracy @ V <sub>SENSE</sub> = 100mV %	Quiescent current µA	Gain output/V <sub>SENSE</sub>	Bandwidth MHz	Package
ZXCT1008	Automotive temperature range micro-power current monitor	2.5 to 20 <sup>(1)</sup>	±2.5	4	10mA/V	2	SOT23
ZXCT1009	Micro-power current monitor	2.5 to 20 <sup>(1)</sup>	±2.5%	4	10mA/V	2	SM8 SOT23
ZXCT1010	Micro-power current monitor with improved offset	2.5 to 20	±2.5%	3.5	10mA/V	2	SOT23-5 <sup>A</sup>
ZXCT1011	Simple current monitor with improved temperature drift	2.5 to 20 <sup>(1)</sup>	±2.5%	4	10mA/V <sup>(2)</sup>	1.5	SOT23-5 <sup>B</sup>
ZXCT1012	Reduced height micro-power current monitor	2.5 to 20	±2.5%	3.5	10mA/V	2	TDFN3x3-5 TSOT23-5
ZXCT1020	Low offset current monitor	2.5 to 20	±2%	25	Prog.	1	SOT23-5 <sup>D</sup>
ZXCT1050	Wide common-mode current monitor	2.5 to 20	±3%	50	Prog.	1	SOT23-5 <sup>C</sup>

<sup>(1)</sup> Relative to I<sub>OUT</sub> <sup>(2)</sup> Gain with R<sub>SH</sub> at 120Ω

## Application notes

AN39 Current measurement applications handbook

AN45 High voltage current monitoring using the ZXCT1009 and ZXCT1010 in power supplies

AN46 The use of Zetex current monitors with the Polyswitch™ overcurrent device

## Connection diagrams

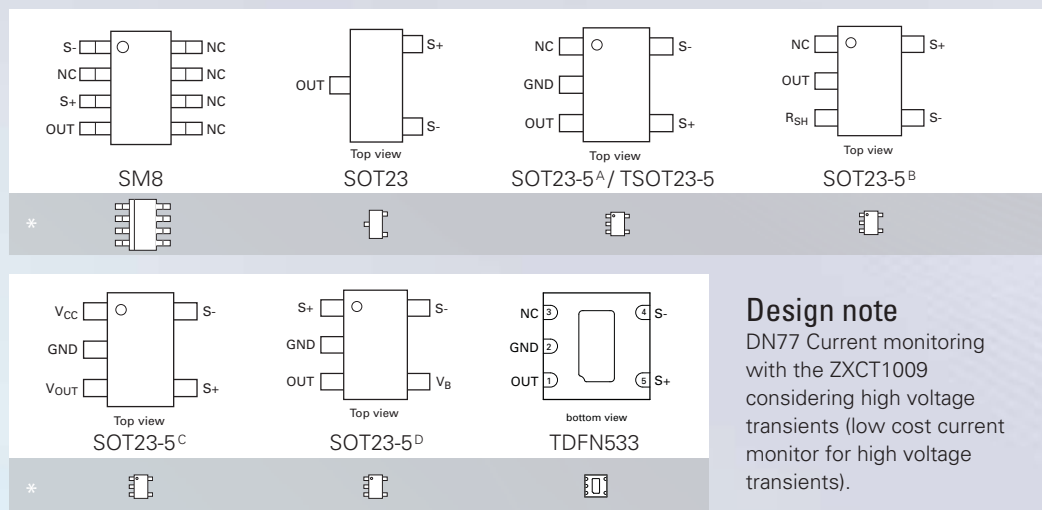

## Design note

DN77 Current monitoring with the ZXCT1009 considering high voltage transients (low cost current monitor for high voltage transients).

\*Indicative relative size

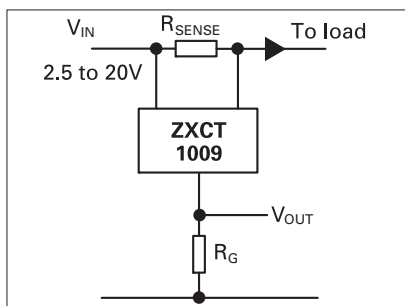

The ZXCT1008 and ZXCT1009 are the simplest of the current monitors. The output is a current which is proportional to the sense voltage, measured across a low value shunt resistor,  $R_{sense}$ . The output current can be converted to a voltage and scaled by choice of an appropriate resistor,  $R_{out}$ . Quiescent current of only  $4\mu A$  has minimal impact on system power efficiency. Operating voltage is from 2.5V to 20V, which makes these parts suitable for a wide range of applications.

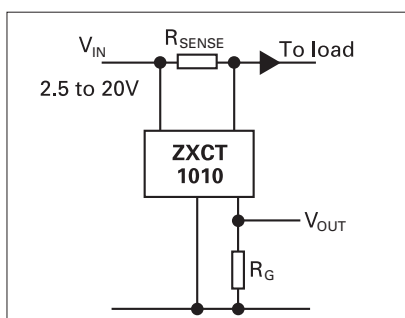

The ZXCT1010 and ZXCT1012 have the same characteristics as the ZXCT1009 but with a separate ground pin to avoid the circuit current flowing through the output resistor.

This reduces the current offset and improves accuracy particularly at lower sense voltages.

The ZXCT1012 has the same performance as the ZXCT1010 but in thinner packages.

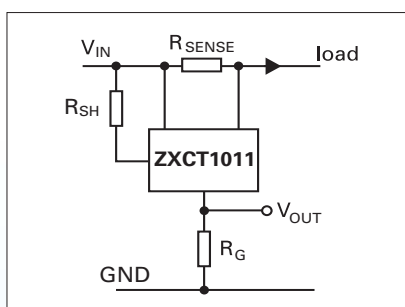

The ZXCT1011 uses an external resistor to determine its transconductance resulting in a much lower temperature coefficient.

This gives a better accuracy at temperature extremes without losing any of the parameters found in ZXCT1008/9 devices.

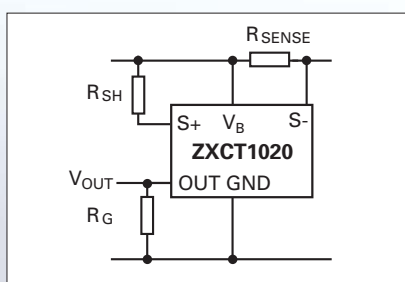

The ZXCT1020 uses an external resistor to set its transconductance and allows its offset to be trimmed.

This increases the ZXCT1020 accuracy over the ZXCT1010 while maintaining the versatility of the ZXCT101.

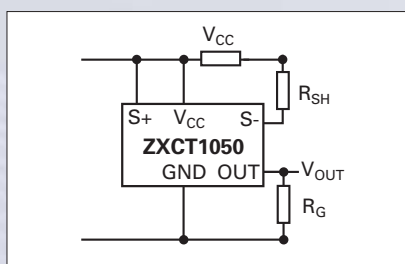

The ZXCT1050 is the current output version of the ZXCT1051. Two resistors are now off-chip; 1 sets the transconductance and other sets the gain.

Its offset is trimmed improving accuracy at small sense voltages

# Voltage output current monitors

ZXCT current monitors with voltage output convert a high-side current measurement to a ground-referred voltage output thereby greatly simplifying high-sided current measurements. The devices offer an internally set gain with low offset voltages and low temperature drift, which optimizes performance at low sense voltages.

## Features

- High-side current sensing
- Output voltage scaling
- Up to 2.5V sense voltage
- 2.5V - 20V supply range
- 1% typical accuracy

## Applications

- Over-current monitor
- Battery chargers
- Smart battery packs
- Power management
- DC motor control

Part number	Description	V <sub>IN</sub> V	Accuracy @ V <sub>SENSE</sub> = 100mV %	Quiescent current µA	Gain output/V <sub>SENSE</sub>	Bandwidth MHz	Package
ZXCT1021	Voltage output	2.5 to 20	±2%	25	10V/V	1	SOT23-5 <sup>A</sup>
ZXCT1022	Voltage output	2.5 to 20	±3%	25	100V/V	1	SOT23-5 <sup>A</sup>
ZXCT1030	Enhanced function with internal reference and comparator	2.5 to 20	±3%	270	10V/V	6	SO8 <sup>A</sup>
ZXCT1032	High side inrush current limit controller	9.5 to 21	-	1600	10V/V	-	SO8 <sup>B</sup>
ZXCT1041	Bidirectional voltage output with direction flag	2.7 to 20	±3%	35	10V/V	0.3	SOT23-5 <sup>B</sup>
ZXCT1051	Precision wide input range current monitor	0 to V <sub>CC</sub> -2	±3%	50	10V/V	2	SOT23-5 <sup>C</sup>
ZXCT1080	High voltage High-Side Current Monitor	3 to 60	±3%	30	10V/V	0.5	SOT23-5 <sup>C</sup>
ZXCT1081	High voltage High-Side Current Monitor	3 to 40 <sup>(1)</sup>	±3%	30	10V/V	0.5	SOT23-5 <sup>C</sup>

<sup>(1)</sup> 60V transient

## Connection diagrams

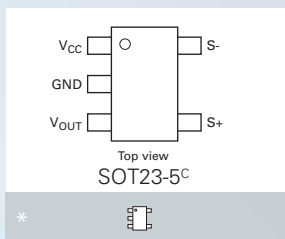
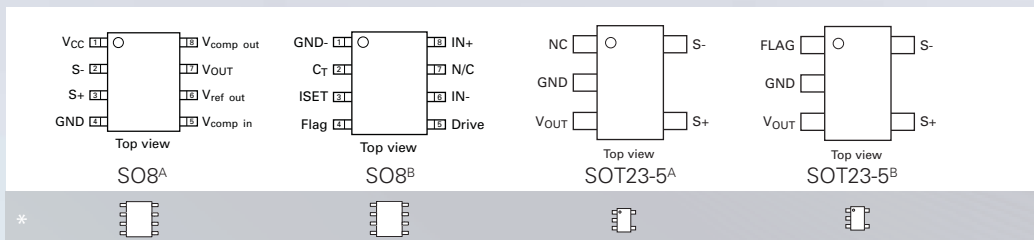

## Application notes

AN39 Current measurement applications handbook

AN46 The use of Zetex current monitors with the Polyswitch™ overcurrent device

\*Indicative relative size



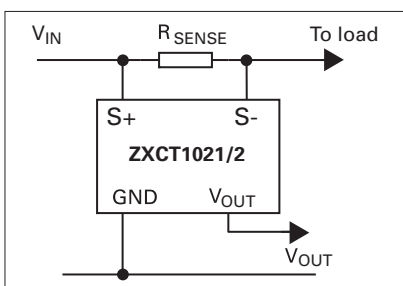

The ZXCT1021 and ZXCT1022 are voltage output current monitors, with fixed gain scaling.

$$V_{out} = \text{Gain} \times V_{SENSE}$$

The output is scaled internally by 10 on the ZXCT1021 and 100 on the ZXCT1022. This scaling allows low value sense resistors to be used, thus reducing power dissipation and voltage drop. The ZXCT1021 and ZXCT1022 are pin compatible with the ZXCT1010, which provides an easy upgrade path for improved performance.

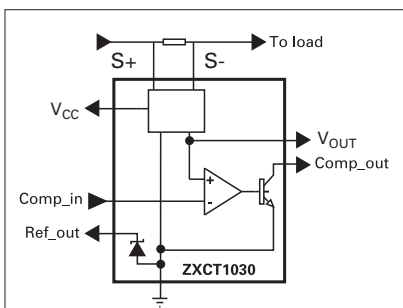

The ZXCT1030 is a voltage output current monitor with fixed gain scaling of 10. A non-latching output comparator and 1.24V voltage reference are also included on-chip to make more integrated solutions possible. Operating voltage range is 2.2V to 20V and quiescent current is only 270µA. A separate V<sub>CC</sub> supply ensures the device gives an output under short circuit conditions. When the V<sub>S+</sub> and V<sub>S-</sub> falls below about 2.2V, then the comparator defaults to the asserted state. By feeding reference output to the comparator input a simple and compact over-current protection circuit can be developed.

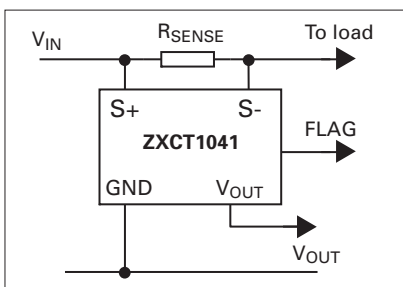

The ZXCT1041 is a bidirectional voltage output current monitor with direction flag. The flag is an open collector output enabling it to be coupled to a wide range of logic level voltages.

The voltage output pin is analog and is internally scaled to 10 times V<sub>SENSE</sub>. The ZXCT1041 operates from 2.7V to 20V enabling it to work in a wide range of applications including automotive, motor control and battery gas-gauging. Apart from its flag output the ZXCT1041 is pin compatible to the ZXCT1021.

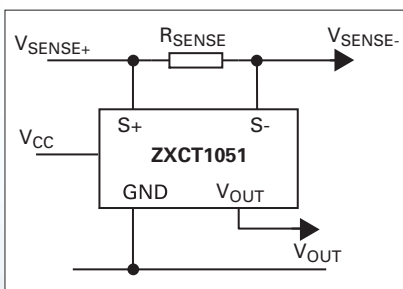

The ZXCT1051 is a wide common-mode range voltage output current monitor designed to measure at voltages ranging from under supply to ground. This makes the device suitable for systems which need to function under short circuit conditions. An auxiliary power supply is required to feed the device and keep the internal circuitry active. V<sub>CC</sub> range is 20V to 3V and V<sub>S+</sub> is V<sub>CC</sub> - 2V to 0V. Supply current is 50µA and the performance is similar to the ZXCT1021, with internal gain setting of 10.

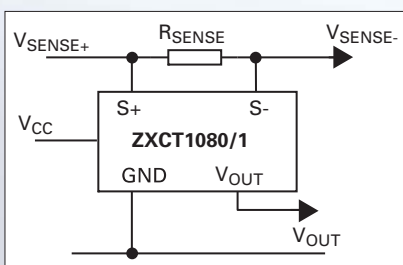

The ZXCT1081 has a wide continuous common-mode input range from 3V to 40V (60V transient). The ZXCT1080 extends the continuous common mode range to 60V. This allows it to measure currents in a wide range of applications ranging from computer power supplies to automotive.

A separate power supply pin provides power to an internal buffer lowering the output impedance

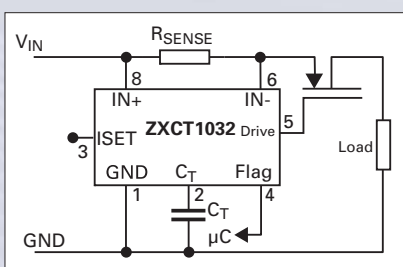

The ZXCT1032 provides in-rush current limiting and over current protection functions and when used with an external P-MOSFET behaves as an electronic fuse. At power up the load current is gradually increased; protecting input power supply from large capacitive loads. In over-current protection mode the device is transparent; just measuring the output current. When the over-current threshold is exceeded the device switches off the MOSFET protecting both the load and supply rail from damage. The ZXCT1032 will auto retry.

# Voltage references

## Section 5.0



The Zetex range of voltage reference devices significantly extends the performance of many industry standard parts. Offered in a choice of space saving packages, they provide the opportunity to reduce power consumption and increase operating temperature.

### Contents

Shunt regulators	59
Micro-power voltage regulators	60
Industry standard references	61



# Shunt regulators

These devices improve on industry standard products, notably their quiescent current is substantially lower than competitive alternatives. 2.5V devices are available as well as 1.24V for low voltage circuits. Industrial and extended temperature range devices are available. The ZTL range matches most TL431/2 specifications for applications where quiescent current is not critical.

## Features

- No stabilizing capacitor required
- Min. knee current 50µA
- ±2.5%, 2% 1% and 0.5% (selected devices) tolerance
- Small outline SOT23 and SC70 packages
- Improved temperature coefficient

## Applications

- Battery powered and portable equipment
- Metering and measurement systems
- Precision power supplies
- Switch mode power supplies

Part number	Operating temperature range °C	Reference voltage V	Min. output voltage V	Max. output voltage V	Min. cathode current µA	Max. cathode current mA	Tolerance @25°C <sup>(1)</sup> %	Package
ZXRE060	-40 to 85	0.6	0.2	18	-	20	0.5, 1	SOT23 SC70-6
ZR431L	-40 to 85	1.24	1.24	10	100	25	1, 2.5	SOT23 <sup>A</sup>
TLV431	-40 to 125	1.24	1.24	18	100	15	0.1, 1	SOT23 <sup>A</sup> SC70-6 SOT23-5
ZHT431	-55 to 125	2.5	2.5	20	50	100	1, 2	SOT23 <sup>A</sup>
ZR431	-40 to 85	2.5	2.5	20	50	100	0.5, 1, 2	SOT223 SOT23 <sup>A</sup>
ZTL431	-40 to 125	2.5	2.5	20	1000	100	0.5, 1	SOT23 <sup>B</sup> SC70-6 SOT23-5
ZTL432 <sup>(2)</sup>	-40 to 125	2.5	2.5	20	1000	100	0.5, 1	SOT23 <sup>A</sup>

<sup>(2)</sup> Matches pinout of TL432 in SOT23

**Application note** AN27 ZR431 application note

## ZTL competitive comparison

Part number	ZR431	ZTL431	TL431
Bandgap voltage		2.5V	
Initial tolerance	2, 1, 0.5%	1, 0.5%	2, 1, 0.5%
Operating voltage (max.)	20V	20V	36V
Min. operation current (typ.)	<b>50µA (max.)</b>	400µA	400µA
Operating current range	0.05 to 100mA	1 to 100mA	1 to 100mA
Temperature coefficient (max.)	<b>55ppm/°C</b>	50ppm/°C (typ.)	50ppm/°C (typ.)
Dynamic impedance (max.)	0.75Ω	0.75Ω	0.75Ω
Temperature range (max.)	-55 to 125°C	<b>-40 to 125°C</b>	-40 to 85°C
Packages	SOT23 and SOT223	SOT23, SC70-6, SOT23-5	SOT23, TO92 & SOT23-5

**(Bold)** denotes improvement of specification.

## Connection diagrams

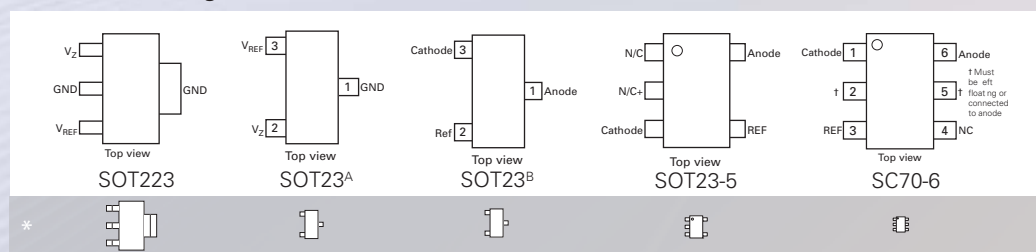

\*Indicative relative size

# Micro-power voltage references

The ZRB devices operate from a minimum operating current of 50µA with temperature coefficients generally of 90ppm/°C maximum.

The ZXRE devices offer even lower minimum operating currents down to 8µA.

Zetex micro-power references are designed to operate over the temperature range -40 to 85°C.

## Features

- Temperature coefficient down to 50ppm/°C
- Minimum (knee) current down to 8µA
- No stabilizing capacitor required
- SOT23 package

## Applications

- Precision power supplies
- Battery powered and portable equipment
- Metering and measurement systems
- Instrumentation
- Test equipment

Part number	Reverse breakdown voltage	Min. current µA	Max. current mA	Max. temperature coefficient ppm/°C	Max. slope resistance Ω	Tolerance @25°C %	Package
ZXRE1004	1.22	8	20	75	0.6	1	SOT23
ZXRE125	1.22	8	20	75	0.6	0.5, 1, 2	SOT23
ZRC250	2.5	20	5	90	1	1, 2	SOT23
ZRC330	3.3	20	5	50	2	1, 2	SOT23
ZRC400	4.096	23	5	90	2	1	SOT23
ZRB500	5	50	15	50	1.5	1, 2	SOT23
ZRC500	5	25	5	90	2	1	SOT23

## Application circuit

Micropower 2.5V reference

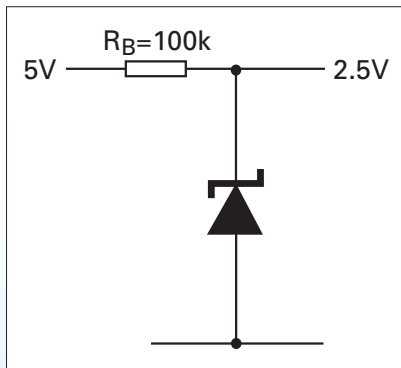

## Connection diagram

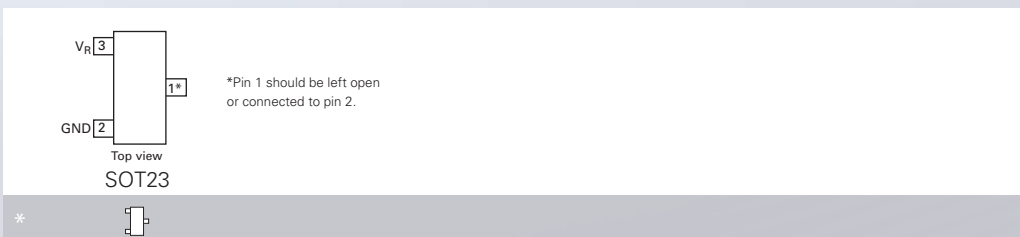

\*Indicative relative size

## Industry standard references

Zetex has taken the features of its micro-power references to provide improved versions of three industry standard families.

ZXRE4041 offers a better minimum operating current than the LM4041. The ZR4040 family also offers a better minimum operating current than the LM4040. ZR285 has a better temperature coefficient than the LM285-2.5.

Zetex micro-power references are offered in industrial and extended temperature versions.

### Features

- 0.5%, 1%, 2% and 3% tolerance
- 20ppm/°C typical temperature coefficient
- 20µA knee current
- SOT23 package

### Applications

- Precision power supplies
- Battery powered equipment
- Portable communications devices
- Notebook and palmtop computers

Part number	Competitor part number	Reverse breakdown voltage	Min. current µA	Max. current mA	Max. temperature coefficient ppm/°C	Max. slope resistance Ω	Tolerance @25°C %	Package
ZXRE4041	LM4041	1.225	30	12	100	0.92	0.5, 1, 2	SOT23
LM4041	LM4041	1.225	30	12	100	0.6	0.5, 1	SOT23, SC70-5*
ZR285-2.5	LM285-2.5	2.5	20	20	90	1	1	SOT23
ZR4040-2.5	LM4040-2.5	2.5	50	20	90	2	0.5, 1, 2	SOT23
LM4040-2.5	LM4040-2.5	2.5	60	15	100	0.9	0.5, 1	SOT23, SC70-5*
LM4040-3.0*	LM4040-3.0	3	62	15	100	0.9	0.2, 0.5, 1	SOT23, SC70-5*
ZR4040-4.1	LM4040-4.1	4.096	50	20	90	2	1	SOT23
ZR4040-5	LM4040-5.0	5	50	20	90	1.5	1	SOT23
LM4040-5.0	LM4040-5.0	5	60	15	100	1.1	0.5, 1	SOT23, SC70-5*

\*due late Q2, 2008

### LM4040 and LM4041 competitive comparison

Company		Zetex	NSC	Zetex	NSC	Zetex	NSC
Part number		LM4040-25	LM4040-25	LM4040-50	LM4040-50	LM4041	LM4041
Bandgap voltage		2.5V		5.0V		1.225V	
Initial tolerance	%	1, 0.5	2, 1, 0.5, 0.2, 0.1	1, 0.5	2, 1, 0.5, 0.2, 0.1	1, 0.5	2, 1, 0.5, 0.2, 0.1
Min. current	µA	60	60	60	60	60	60
Max. current	mA	15	15	15	15	15	15
Temp co.	ppm/°C	100	100	100	100	100	100
Noise	µV <sub>RMS</sub>	45	35	105	80	60	20
Temp. range	°C	-40 to <b>125</b>	-40 to 85	-40 to <b>125</b>	-40 to 85	-40 to <b>125</b>	-40 to 85
Packages		SOT23 SC70-5	SOT23, SC70-5	SOT23 SC70-5	SOT23, SC70-5	SOT23 SC70-5	SOT23, SC70-5

### Application circuit

Precision 1.225V reference

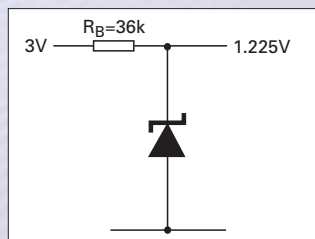

### Connection diagram

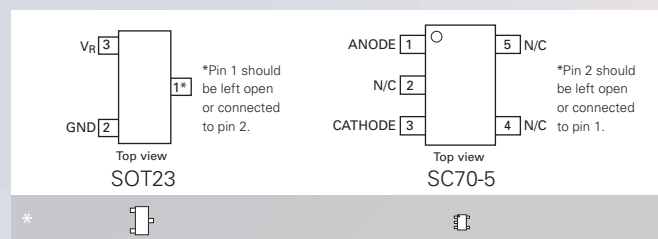

\*Indicative relative size

# Linear regulators

## Section 6.0



Consisting of four distinct product families, the Zetex regulator range provides designers with the means to find the best low power regulator for the job – every time.

The low quiescent current and high current handling of many Zetex regulators means industry standard parts are simply outperformed.

### Contents

Miniature linear regulators	64
Industry standard improved regulators	65
Ultra-low dropout regulators	66
Micro-power low dropout regulators	67

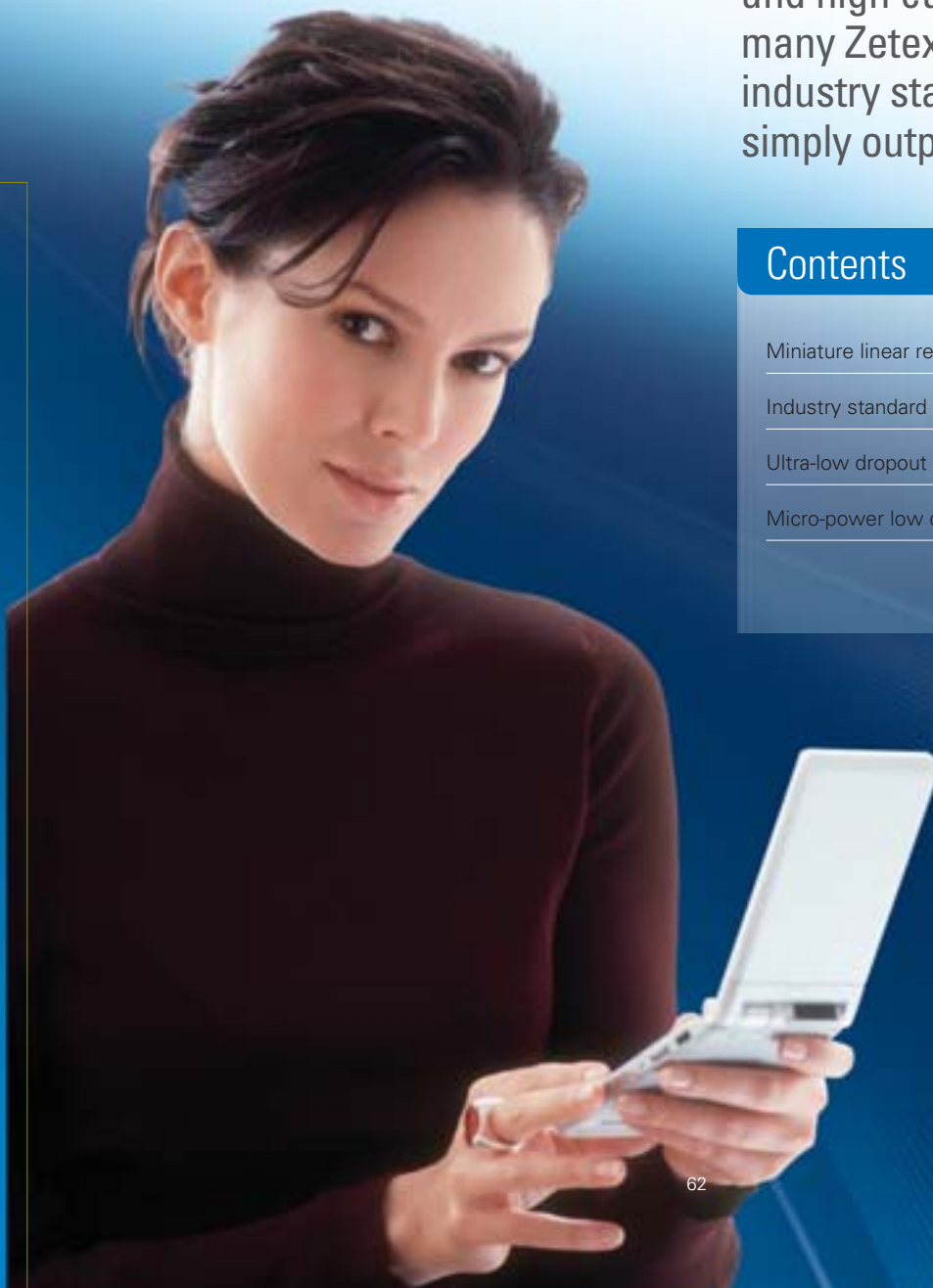

## Linear regulator families

Family	Miniature linear regulators	Improved industry standard equivalents	Ultra-low dropout regulators	Micro-power low dropout regulators
Feature	Small SOT23 package general purpose regulator	Equivalent to 78L range but with lower $I_Q$ and higher $I_{MAX}$	Extremely low dropout voltage and high $I_{MAX}$	Equivalent to MAX8511, MIC5213, LMS5213
Output voltage	2.5, 3.3, 5.0V	3.0, 3.3, 5.0, 10V	3.3, 5.0V	2.5, 2.8, 3.0, 3.3V
Tolerance	±2.5%	±2.5%	±2%	±2%
Input voltage (max.)	20V	20V	20V	5.5V
Dropout voltage (max.)	2V	2V	75mV @ 100mA	280mV @ 100mA
Quiescent current (max.)	40µA to 100µA	600µA	1mA	50µA
Standby current	N/A	N/A	30µA	1µA
Output current (max.)	50mA	200mA	300mA	150mA
Temperature range	-55 to +125°C	-55 to +125°C	-40 to +85°C	-40 to +85°C
Dissipation/power	SOT23 = 500mW	SOT223 = 2W	SM8 = 2W	SC70-5 = 300mW TSOT23-5 = 450mW



# Miniature linear regulators

Designed specifically for applications where space saving is important, the ZMR series is available in the small SOT23 package. These devices supply up to 50mA load current with quiescent current typically down to 30µA. Devices in the ZMR series are designed to operate over the temperature range -55 to 125°C.

The ZMR250 and ZMR500 have had their operating voltage increased to 22.5V and 25V respectively thereby replacing the ZMR25H and ZMR50H.

## Features

- 2.5V, 3.3V and 5V output
- 22.5V, 24V and 25V maximum input voltage
- Output current up to 50mA
- Very low quiescent current (typically 30µA)
- SOT23 package
- -55 to 125°C ambient temperature range

## Applications

- Local voltage regulation
- Ideal for applications where space is critical

Part number	Output voltage <sup>(1)</sup> V	Max. input voltage V	Min. output current mA	Max. quiescent current µA	Typical dropout voltage V	Max. line regulation mV	Max. load regulation mV	Package
ZMR250	2.5	22.5	50	40	1.7	15	30	SOT23
ZMR330	3.3	24	50	170	1.7	10	35	SOT23
ZMR500	5	25	50	70	1.7	15	40	SOT23

(1) Output voltage tolerance 2.5%

## Connection diagram

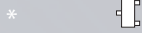
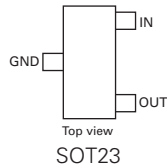

\*Indicative relative size





# Industry standard improved regulators

For circuits requiring higher currents, these devices can handle load currents up to 200mA whilst maintaining a quiescent current of typically only 350µA. The ZSR range offers performance characteristics superior to other local voltage regulators and are in a higher power dissipation package as standard. Devices in the ZSR series are designed to operate over the temperature range -55 to 125°C.

## Features

- 350µA low quiescent current
- Improved line and load regulation
- Output current to 200mA
- SOT223 package

## Applications

- Local voltage regulation
- General voltage regulation

Part number	Output voltage <sup>(1)</sup> V	Max. input voltage V	Min. output current mA	Max. quiescent current µA	Typical dropout voltage V	Max. line regulation mV	Max. load regulation mV	Package
ZSR300	3	20	200	600	1.7	40	25	SOT223
ZSR330	3.3	20	200	600	1.7	30	25	SOT223
ZSR500	5	20	200	600	1.7	40	25	SOT223
ZSR1000	10	20	200	600	1.7	40	30	SOT223

(1) Output voltage tolerance 2.5

## ZSR500 comparison

Family	ZSR500	Industry
Output voltage	5V	5V
Tolerance	<b>±2.5%</b>	±4%
Input voltage (max.)	20V	35V
Dropout voltage (max.)	2V	2V
Quiescent current (max.)	<b>600µA</b>	5.0mA
Output current (max.)	<b>200mA</b>	100mA
Line regulation (max.)	<b>40mV</b>	150mV
Load regulation (max.)	<b>25mV</b>	60mV
Temperature co-efficient (typ.)	<b>0.1mV/C</b>	-0.65mV/C
Package	SOT223	TO92 - SO8 - SOT89

(**Bold**) denotes improvement of specification.

## Connection diagram



\* Indicative relative size

# Ultra-low dropout regulators

The ZLDO regulator series utilizes a novel approach to achieve exceptional performance. The devices use the Zetex SM8 package which has 8 pins and is based on the SOT223 body outline.

The superior design allows the ZLDO to take advantage of the output device saturation voltage to produce an exceptionally low dropout voltage of only 30mV with 100mA load current.

For battery applications low power dissipation is a necessity so the controller circuit design has been optimized to produce a quiescent current of 560µA, with 1mA quiescent current at 300mA load.

A control pin is provided for device disable and a further pin gives a warning flag for low supply input. Devices in the ZLDO series are designed to operate over the temperature range -40 to 85°C.

## Features

- Very low dropout voltage:
  - 6mV dropout at 10mA output
  - 30mV dropout at 100mA output
  - 100mV dropout at 300mA output
- Low quiescent current
- SM8 package

## Applications

- Battery powered devices
- Laptop/palmtop computers
- PDAs

Part number	Output voltage <sup>(1)</sup> V	Max. input voltage V	Dropout voltage <sup>(2)</sup> mV	Max load current mA	Quiescent current µA	Shutdown current µA	Load regulation <sup>(3)</sup> mV	Line regulation mV	Package
ZLDO330	3.3	20	30	300	560	11	78	52	SM8
ZLDO500	5	20	30	300	560	11	23	70	SM8

(1) Output voltage tolerance 2% (2) I<sub>L</sub>=100mA (3) I<sub>L</sub>=10 to 300mA %

## Connection diagram

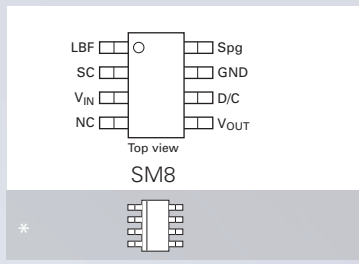

\* Indicative relative size

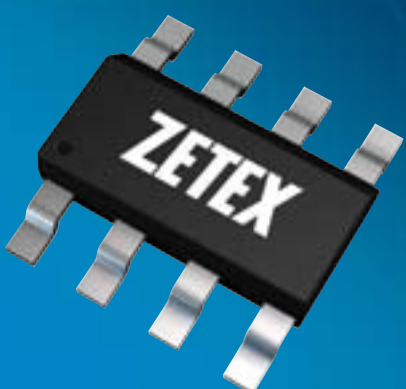

# Micro-power low dropout regulators

The ZXCL range of low dropout regulators offers a very high performance in a very small package. They are available in the tiny SC70-5 pin package as well as the industry standard SOT23-5 package. The devices are inherently stable with tantalum and ceramic capacitors. Low output noise is achieved without the need for bypass capacitors.

## Features

- Low 85mV dropout at 50mA load
- Ultra small SC70-5 package
- 25µA typical ground pin current
- 2.5, 2.8, 3.0 and 3.3V output
- Output voltage tolerance 2%

## Applications

- Portable and battery powered equipment
- Cellular and cordless phones
- Palmtop and laptop computers
- Cameras, camcorders, personal stereos, PDAs

Part number	Output voltage <sup>(1)</sup>	Max. input voltage	Dropout voltage <sup>(2)</sup>	Max. load current	Quiescent current	Shutdown current	Output noise voltage <sup>(3)</sup>	Package
	V	V	mV	mA	µV	µA	µVrms	
ZXCL250	2.5	5.5	85	100(3)	25	0.01	50	SOT23-5 SC70-5 <sup>A</sup>
ZXCL5213V25	2.5	5.5	85	100(3)	25	0.01	50	SC70-5 <sup>B</sup>
ZXCL280	2.8	5.5	85	150	25	0.01	50	SOT23-5 SC70-5 <sup>A</sup>
ZXCL5213V28	2.8	5.5	85	150	25	0.01	50	SC70-5 <sup>B</sup>
ZXCL300	3	5.5	85	150	25	0.01	50	SOT23-5 SC70-5 <sup>A</sup>
ZXCL5213V30	3	5.5	85	150	25	0.01	50	SC70-5 <sup>B</sup>
ZXCL330	3.3	5.5	85	150	25	0.01	50	SOT23-5 SC70-5 <sup>A</sup>
ZXCL5213V33	3.3	5.5	85	150	25	0.01	50	SC70-5 <sup>B</sup>

(1) Output voltage tolerance 2% (2) I<sub>L</sub>=50mA (3) Limited by R<sub>DS(on)</sub> and power dissipation effects with 3 volt input voltage

## ZXCL LDO comparison

Family	MIC5213	ZXCL	MAX8511
Output voltage	2.5, 2.6, 2.7, 2.8, 3.0, 3.3, 3.6, 5.0	2.5, 2.8, 3.0, 3.3	1.5, 1.8, 2.5, 2.7, 2.8, 2.85, 3.0, 3.3, 4.5
Tolerance at 1mA	±3%	±2%	±1%
Tolerance at 100mA	-	±3%	±3%
Temperature co-efficient (typ.)	200ppm/°C	<b>-15ppm/°C</b>	-
Input voltage (max.)	16	5.5	6
Dropout voltage (typ.)	250mV @ 50mA	85mV @ 50mA	80mV @ 80mA
Dropout voltage (max.)	600mV @ 80mA	280mV @ 100mA	170mV @ 80mA
Quiescent current (max.) no load	180µA typ.	<b>50µA</b>	90µA
Output current (max.)	80mA	<b>150mA</b>	120mA
Shut down current (max.)	10µA	1µA	1µA
Line regulation (max.)	0.3%	<b>0.1%</b>	No max.
Load regulation (max.) 1mA to 100mA	0.5%	<b>0.04%</b>	No max.
Packages	SC70-5 <sup>B</sup>	SC70-5 and SOT23-5	SC70-5 <sup>A</sup>

(Bold) denotes improvement of specification.

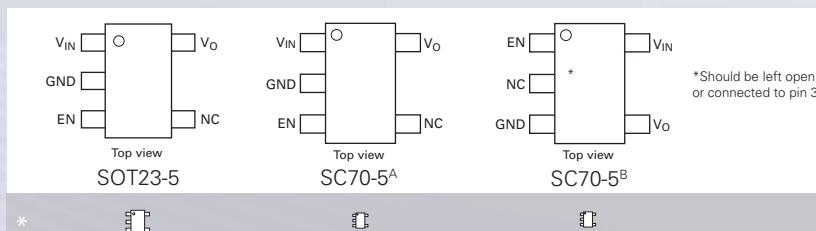

\* Indicative relative size



# DC-DC boost converters

## Section 7.0



Generating target voltages with the greatest efficiency possible is the goal of the Zetex series of DC-DC boost converters.

Optimized for battery-powered applications, they are purpose-designed to support today's low voltage, low power supply rails.

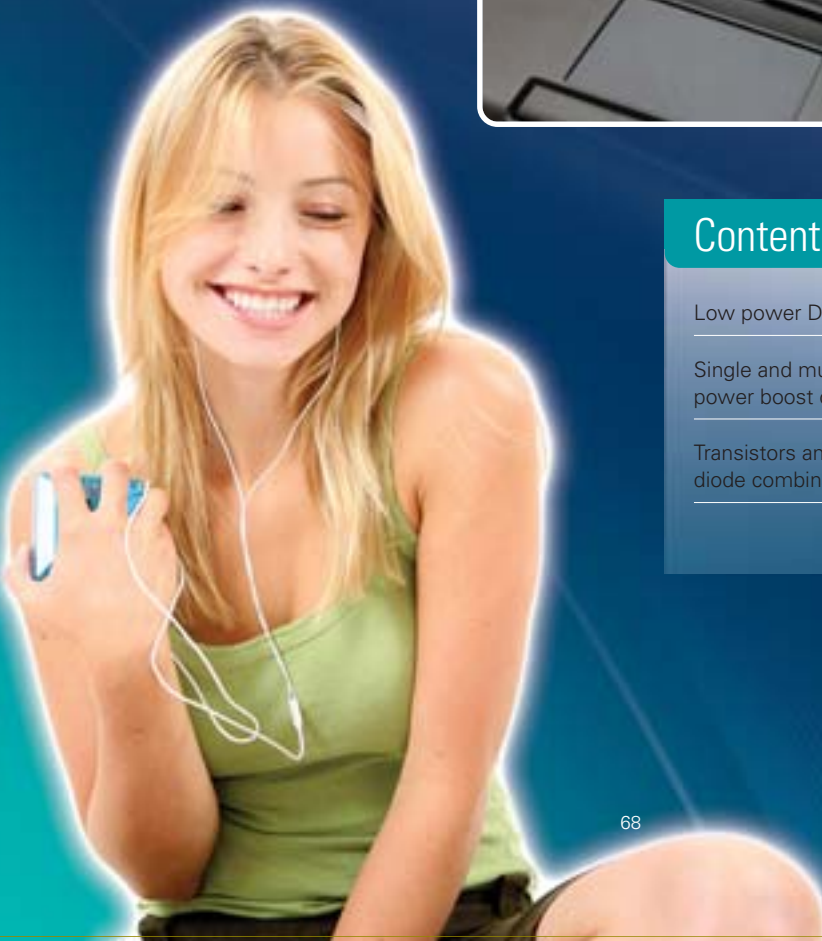

### Contents

Low power DC-DC boost converters	69
Single and multi-cell system power boost controllers	70
Transistors and Schottky diode combinations	71

# Low power DC-DC boost converters

The ZXLD1601/1615 are boost converters for low power rails. They integrate an internal NMOS switch and current sensing resistor thereby saving PCB space and cost. They operate directly from one Li-Ion cell and provide adjustable bias voltages of up to 28V, ideal for LCD and OLED displays.

The ZXLD1615 is pin compatible with LT1615.

## Features

- Wide input voltage range: 2.5V to 5.5V
- Adjustable output voltage up to 28V
- Low shutdown current
- 85% efficiency
- PWM and analog control input
- Small surface mount packages

## Applications

- PDA's
- Cellular phones
- Digital cameras
- Portable internet appliances
- Notebook and palmtop computers
- LCD and OLED bias

Part number	Input voltage range $V_{IN}$	Output voltage range (1) V	Shutdown current Max. $\mu A$	Quiescent current $\mu A$	Efficiency %	Switching frequency kHz	Package
ZXLD1601	2.5 - 5.5	$V_{IN}$ to 28	0.1	60	85	1000	SC70-6
ZXLD1615	2.5 - 5.5	$V_{IN}$ to 28	0.1	60	85	1000	TSOT23-5

(1) Limited only by voltage rating of external bipolar or MOSFET transistor ( $V_{CE0}/B_{VDSS}$ )

## Application circuit

OLED and LCD bias generator

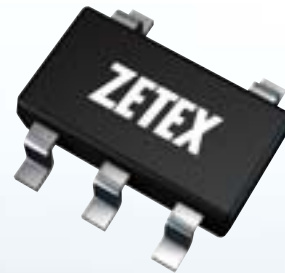
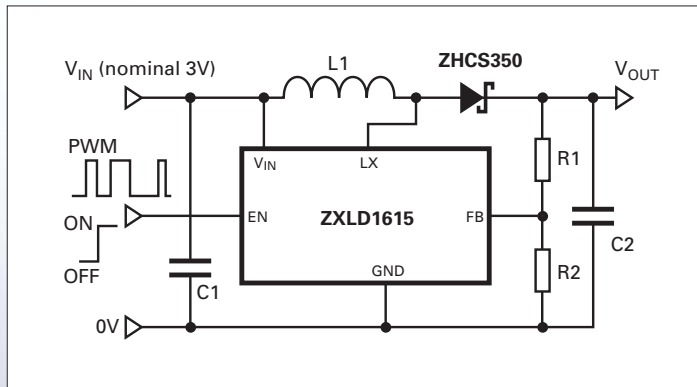

## Connection diagrams

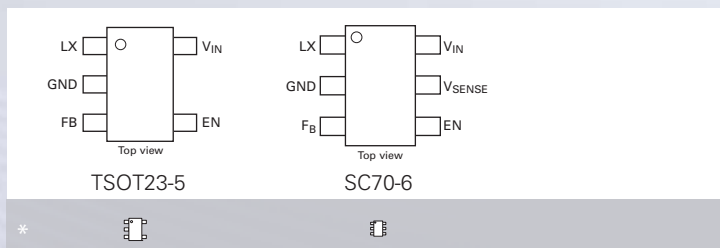

\*Indicative relative size

# Single and multi-cell system power boost controllers

The ZXSC100/410/420 are voltage mode inductive boost controllers aimed at providing power rails from battery supplies. The ZXSC410/420 provide any regulated voltage above  $V_{IN}$  from dual cell and Li-Ion cells with a typical line regulation of 1%. The ZXSC420 option provides an 'end of regulation' flag which uses all available battery energy before signalling a shutdown. The ZXSC100 caters for single cell operation with a guaranteed start up under full load conditions down to 1V. All products feature a programmable peak current to optimize efficiency and supply requirements. Maximum output voltages are limited only by the rating of the external switching device.

The ZXSC440, although intended for camera flash applications, combines the shutdown and end of regulation features of the ZXSC410 and ZXSC420 respectively.

## Features

- Typical 1% load and line regulation - ZXSC410/420
- 4.5µA typical shutdown current - ZXSC410/440
- End of regulation flag - ZXSC420/440
- Single cell operation - ZXSC100
- Programmable peak switch current

## Applications

- System supplies from dual cell and Li-Ion cells - ZXSC410/420
- LCD bias voltage supplies - ZXSC410/420
- System supplies from single alkaline, NiCad or NiMH cells - ZXSC100
- System supplies from solar cells - ZXSC100
- Camera flash - ZXSC440

Part number	Input voltage range V	Output voltage range (1) V	Shutdown current µA	Typical Quiescent current µA	Efficiency %	Package
ZXSC100	0.93 - 3.5	$V_{IN}$ to $V_M$	-	150	82	SO8
ZXSC410	1.8 - 8.0	$V_{IN}$ to $V_M$	4.5	150	85	SOT23-6 <sup>A</sup>
ZXSC420	1.8 - 8.0	$V_{IN}$ to $V_M$	-	150	85	SOT23-6 <sup>B</sup>
ZXSC440	1.8 - 8.0	$V_{IN}$ to $V_M$	4.5	150	85	MSOP8

(1)  $V_M$  - limited only by voltage rating of external bipolar or MOSFET transistor ( $V_{CE0}/BV_{DSS}$ )

## Application circuit

ZXSC410 two cell boost converter

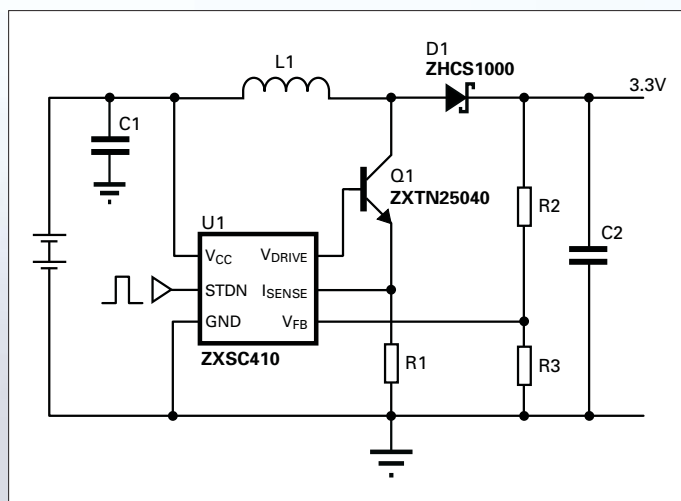

## Application notes

- AN33 ZXSC100 single cell DC-DC converter LED driving applications
- AN34 ZXSC100 power supply for digital still cameras

# Transistor and Schottky diode combinations

Zetex DC-DC boost controller ICs are supported by a complementary range of discrete components.

	Device	Specification		Part number	Package
		$V_{CEO}/BV_{DSS}/V_R$ V	$I_C/I_D/I_F$ A		
Switch devices	NPN bipolar	15	6	ZXTN23015DFH	SOT23
		15	5	ZXTN25015DFH	SOT23
		20	4.5	ZXTN25020DFH	SOT23
		40	4	ZXTN25040DFH	SOT23
		50	3.5	ZXTN25050DFH	SOT23
Rectifier diodes	Schottky diodes	30	$I_{PK} < 0.2$	BAT 54	SOT23
		40	$I_{PK} < 0.4$	ZHCS400	SOD323
		40	$I_{PK} < 0.5$	ZHCS500	SOT23
		40	$I_{PK} < 1.0$	ZHCS1000	SOT23
Combination devices	NPN bipolar + Schottky diode	20	4.5	ZX3CDBS1M832	DFN832
		40	1.85		

## Connection diagrams

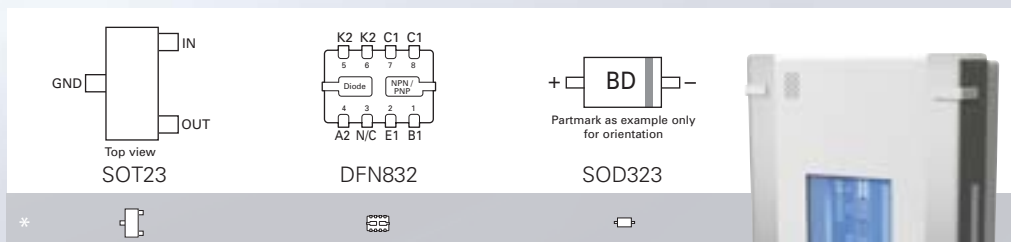
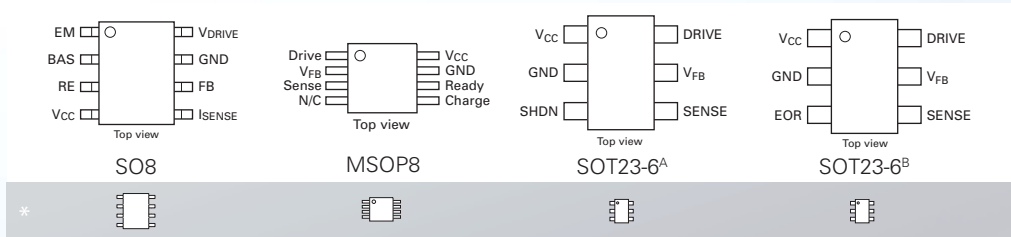

\*Indicative relative size



# Special functions

## Section 8.0

### Contents

Supply voltage monitors (uP generators)	73
Siren Driver	74
Temperature sensor	74
Magneto-resistive sensors	75

Through its expertise in analog chip design Zetex has been able to complement its power management ICs with a unique series of special function ICs that solve some quite specific technical challenges for a wide range of applications.





# Supply voltage monitors (microprocessor reset generators)

These devices are three terminal voltage monitoring circuits used in microprocessor systems. They provide a 'power on reset' function and produce a system reset 'low' on power fail. A selection of reset thresholds are available. All devices are designed to operate over the temperature range -40 to 85°C.

## Features

- Automatic reset generation
- Guaranteed operation from 1 volt
- High output current

## Applications

- Microprocessor systems
- Computers and computer peripherals
- Automotive electronics

Part number	V <sub>CC</sub> V	Threshold voltage V	Hysteresis mV	Max. output sink current mA	Input voltage range V	Max. quiescent current µA	Package
ZSM300	3	2.63	20	60	1 to 6.5	190	SOT223
ZM33164-3	3	2.68	60	60	1 to 10	190	SOT223
ZSM560	5	4.6	20	60	1 to 6.5	200	SOT223

## Connection diagram

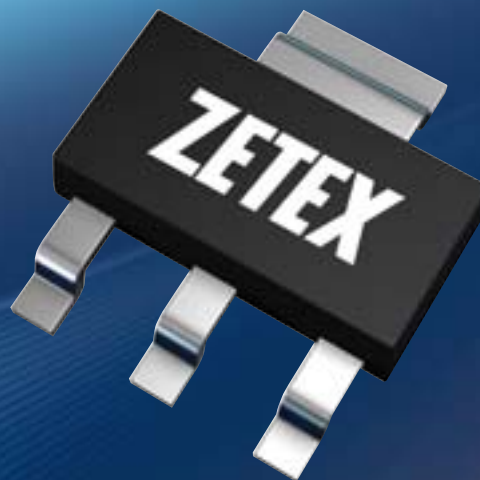

## Siren driver

The ZSD100 is a swept frequency alarm signal generator for static and automotive security alarm systems. Including an audio frequency signal generator, low frequency sweep generator, disable circuitry and output driver stages, it provides all the functions needed to produce a standard siren signal.

### Features

- Wide supply voltage range
- Low current requirement
- Needs few external components
- Supports single-ended or push-pull output stages
- User selected audio and sweep frequencies

Part number	Supply Voltage range V	Supply current		Output current source/sink mA	Low frequency oscillator range		Oscillator output frequency range		Package
		Operating mA	Standby μA		Min. Hz	Max. Hz	Min. Hz	Max. Hz	
ZSD100	4 to 18	4	1	5/0.5	0.1	10	100	10000	SO8

### Connection diagram

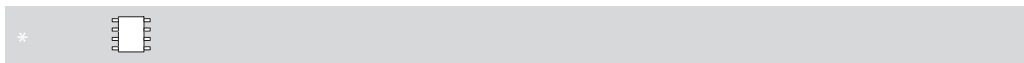
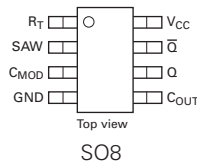

\* Indicative relative size

## Temperature sensor

The ZNI1000 is a thin film Ni Resistance Temperature Detector (RTD). Its high temperature coefficient produces higher signal outputs than other RTDs, resulting in greater accuracy for smaller temperature changes.

The very small SOT23 package results in fast response time and

allows the temperature measurement in different space-saving applications eg: on PCBs near heat generating devices.

### Features

- Resistance at 0°C: 1000Ω
- -55 to 150°C temperature range

- DIN 43760 specification
- SOT23 package

### Applications

- Circuit protection
- Temperature compensation
- Temperature measurement
- Automotive climate control

Part number	Continuous current mA	Resistance T= 0°C I<1mA Ω	Resistance T= 100°C I<1mA Ω	Tolerances class B -55°C to 0°C	Tolerances class B 0°C to 150°C	Package
ZNI1000	4	1000	1618	+/- (0.4+0.028* T )	+/- (0.4+0.007* T )	SOT23

### Connection diagram

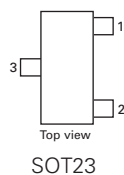

Pin 1 - Ni1000  
Pin 2 - Ni1000  
Pin 3 - Need a good thermal contact for a short response time

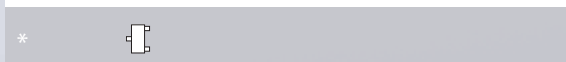

\* Indicative relative size

### Application notes

AN38 - Basic introduction to the use of the ZNI1000 nickel temperature sensor

## Magneto-resistive sensors (linear position)

These extremely sensitive magnetic sensor chips can be used to detect the presence of magnetic parts. Available with single or dual sensors and with or without an internal magnet, the sensors suit a range of linear position measurement applications.

### Features

- Output proportional to magnetic field
- Sensitivity adjustment
- Hysteresis suppression
- ZMY20M and ZMZ20M with internal magnet

### Applications

- Position sensing for process control
- Scalar measurement for compassing
- Fluid metering
- Measurement of current in a conductor without connection

Part number	Supply voltage max V	Output voltage mV/V	Bridge resistance k $\Omega$	Sensitivity mV/V/kA/M	Max. offset voltage mV/V	Internal magnet	Package
ZMY20M	12	18	1.7	5.5	$\pm 1.5$	Yes	SOT223S
ZMZ20M	12	18	1.7	5.0	$\pm 1.5$	Yes	E-line 4-pin

### Connection diagram

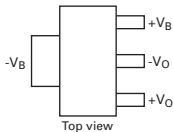

SOT223S

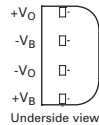

E-Line 4-pin

### E-line devices

The E-Line devices are normally available as loose product in a box (500 piece quantity).



\* Indicative relative size



## Magneto-resistive sensors (angular position)

Incorporating a pair of sensors mounted at 45° to each other, the ZMT31 magnetic sensor enables non-contact detection of angular position and rotation

### Features

- Measures magnetic field  $H_{ROT}$  ( $> 50\text{kA/m}$ )
- Magnetic field  $H_{ROT}$  parallel to the chip surface causes a sinusoidal output signal
- SM8 package
- -40 to 150°C ambient temperature range

### Applications

- Automotive (pedal position etc.)
- Contactless angular measurement
- Contactless potentiometers
- Contactless revolution counting

Part number	Supply voltage V	Sensor chip alignment error	Typical bridge resistance k $\Omega$	Sensitivity <sup>(1)</sup> $S_{\alpha}$	Max. offset voltage <sup>(1)</sup> mV/V	Half bridge symmetry <sup>(1)</sup>	Package
ZMT32	5	$< 2^{\circ}$	3.0	$> \pm 0.2$	$\pm 2$	$< \pm 2.0$	SM8

<sup>(1)</sup>Bridge 1:  $\alpha=0^{\circ}$ , bridge2:  $\alpha=45^{\circ}$

### Connection diagram

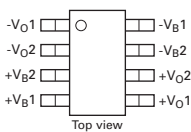

SM8



\* Indicative relative size

# Package information

## Section 9.0

### DFN322

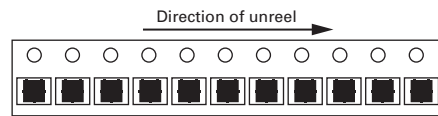
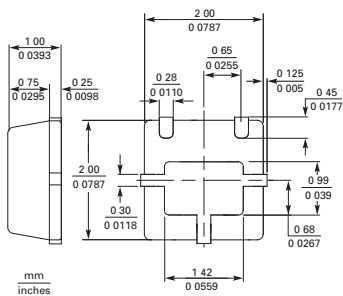

8mm tape width

Part no. suffixed TA = 3k devices per 7" reel

Part no. suffixed TC = 10k devices per 13" reel

### DFN832

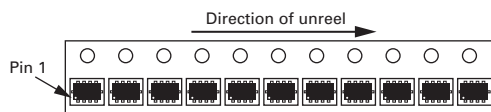
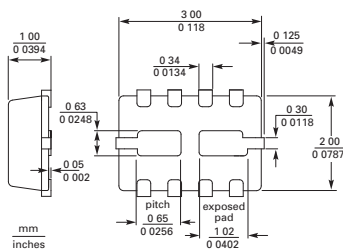

8mm tape width

Part no. suffixed TA = 3k devices per 7" reel

Part no. suffixed TC = 10k devices per 13" reel

### DPAK

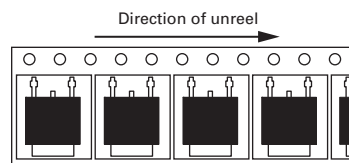
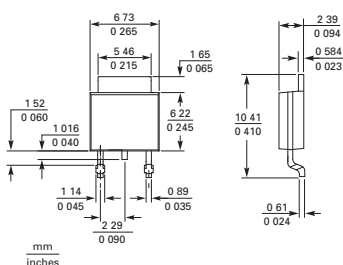

16mm tape width

Part no. suffixed TC = 2.5k devices per 13" reel

### E-Line

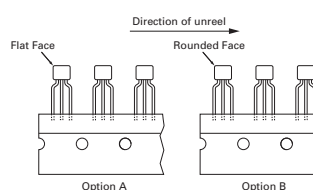
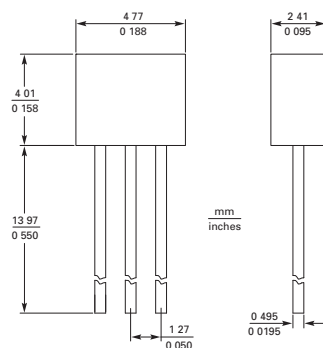

Part no. suffixed STOA = 2k devices on reel

Part no. suffixed STZ = 2k devices folded per box

# MSOP8

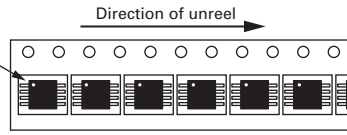
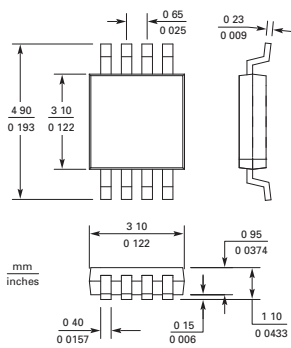

12mm tape width  
 Part no. suffixed TA = 1k devices per 7" reel  
 Part no. suffixed TC = 4k devices per 13" reel

# SC70-5/6

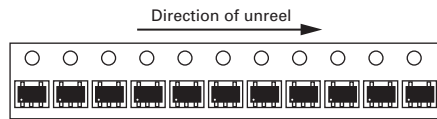
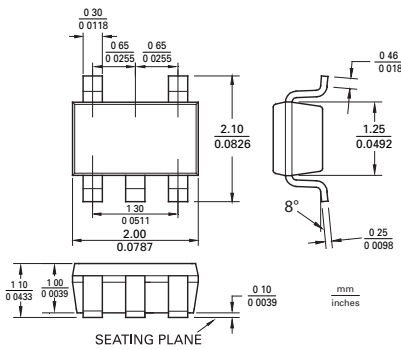

8mm tape width  
 Part no. suffixed TA = 3k devices per 7" reel  
 Part no. suffixed TC = 10k devices per 13" reel

Note: SC70-6 has an additional centre pin.  
 The dimensions are the same as others in the diagram.

# SM8

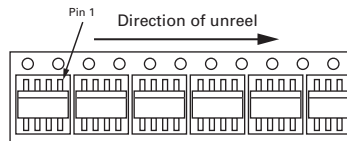
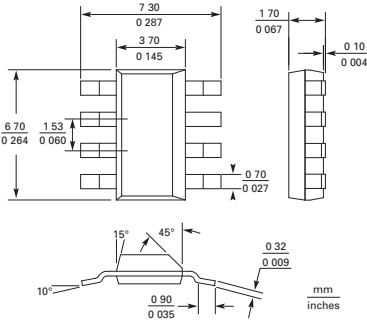

12mm tape width  
 Part no. suffixed TA = 1k devices per 7" reel  
 Part no. suffixed TC = 4k devices per 13" reel

# SOD323

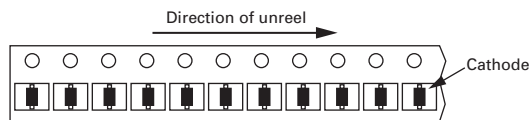
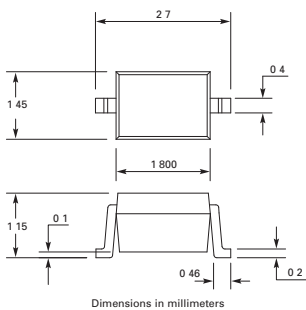

8mm tape width  
 Part no. suffixed TA = 3k devices per 7" reel  
 Part no. suffixed TC = 10k devices per 13" reel

## SOD523

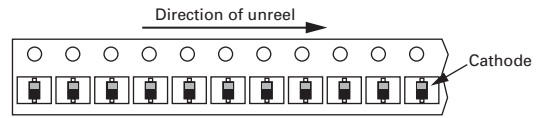
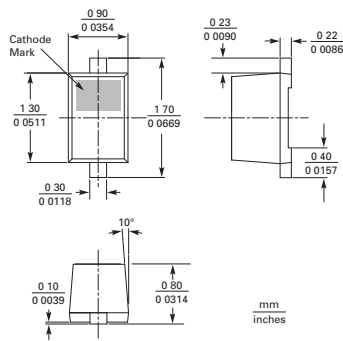

8mm tape width  
 Part no. suffixed TA = 3k devices per 7" reel  
 Part no. suffixed TC = 10k devices per 13" reel

## S08

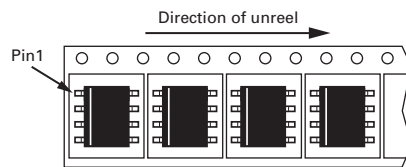
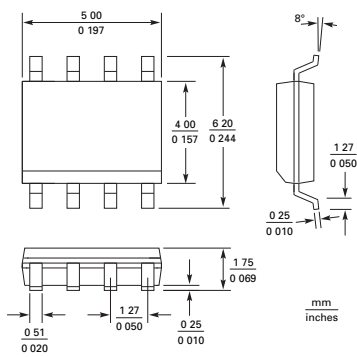

12mm tape width  
 Part no. suffixed TA = 500 devices per 7" reel  
 Part no. suffixed TC = 2.5k devices per 13" reel

## SOT223

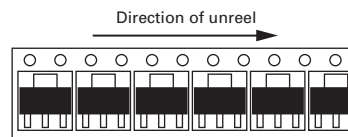
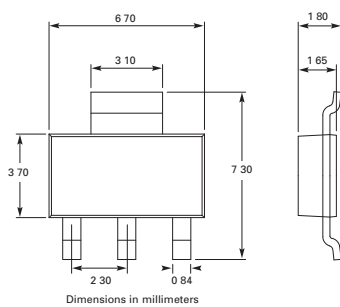

12mm tape width  
 Part no. suffixed TA = 1k devices per 7" reel  
 Part no. suffixed TC = 4k devices per 13" reel

## SOT23

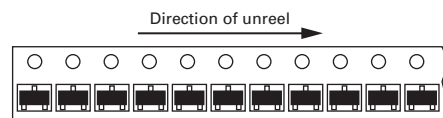
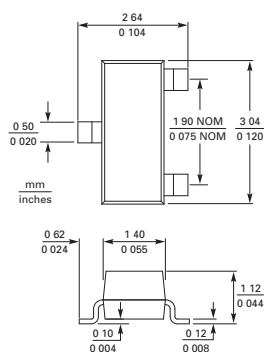

8mm tape width  
 Part no. suffixed TA = 3k devices per 7" reel  
 Part no. suffixed TC = 10k devices per 13" reel  
 Part no. suffixed TD = 500 devices per 7" reel

## SOT23F

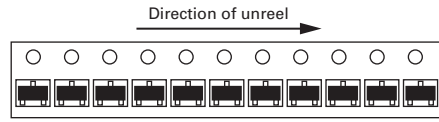
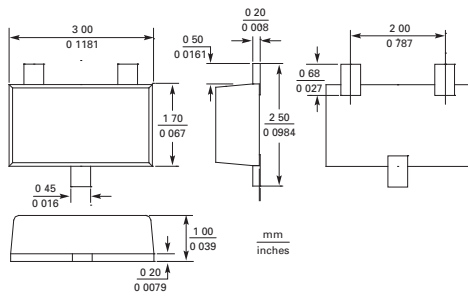

8mm tape width  
 Part no. suffixed TA = 3k devices per 7" reel  
 Part no. suffixed TC = 10k devices per 13" reel

## SOT23-5

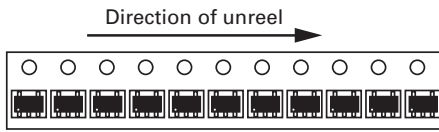
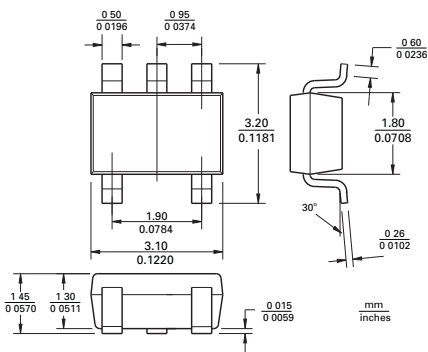

8mm tape width  
 Part no. suffixed TA = 3k devices per 7" reel

## SOT23-6

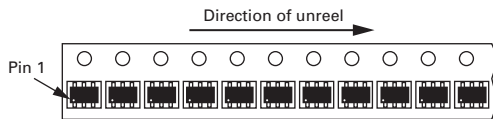
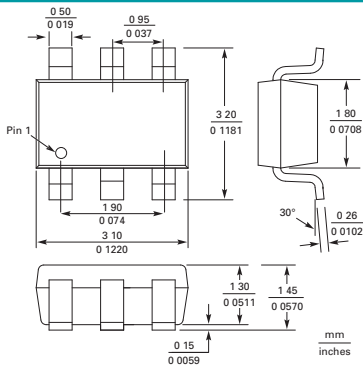

8mm tape width  
 Part no. suffixed TA = 3k devices per 7" reel  
 Part no. suffixed TC = 10k devices per 13" reel

## SOT323

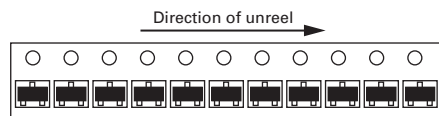
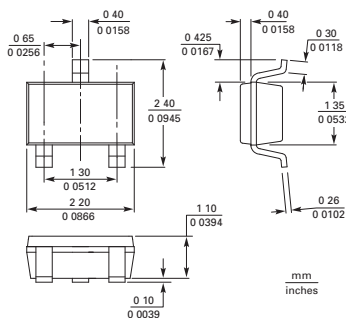

8mm tape width  
 Part no. suffixed TA = 3k devices per 7" reel  
 Part no. suffixed TC = 10k devices per 13" reel

## SOT89

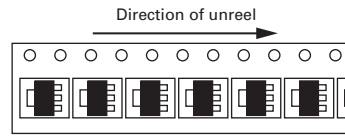
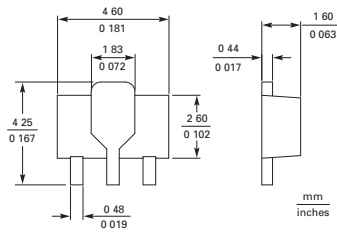

12mm tape width

Part no. suffixed TA = 1k devices per 7" reel

Part no. suffixed TC = 4k devices per 13" reel

## T0220

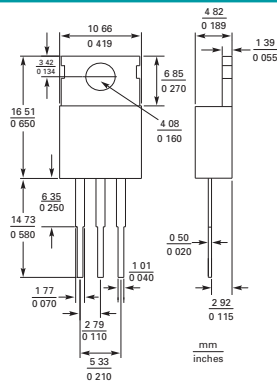

Delivered in tubes - 50 units per tube

## TSOT23-5

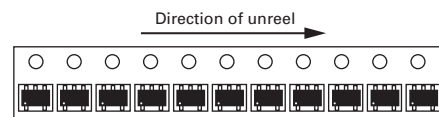
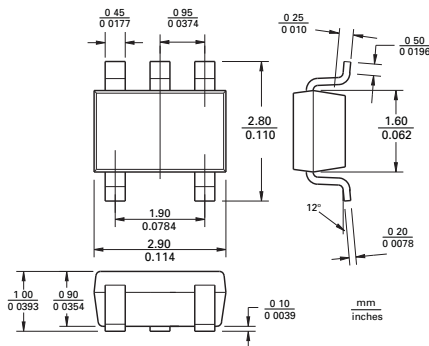

8mm tape width

Part no. suffixed TA = 3k devices per 7" reel

## TDFN533

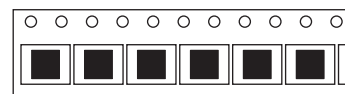
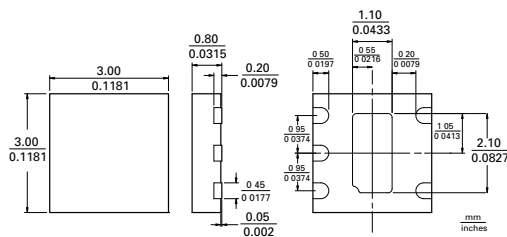

12mm tape width

Part no. suffixed TC = 3k devices per 7" reel





# Thermal data

## Section 9.1

### DFN322

1.5W devices

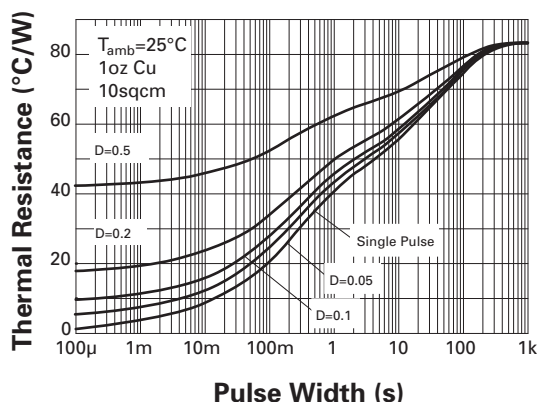

$\theta_{j-a} = 83^{\circ}\text{C/W}$  maximum.

Mounted on an FR4 pcb with 32mm x 32mm coverage of single sided 1oz weight copper in still air conditions.

Derating curves

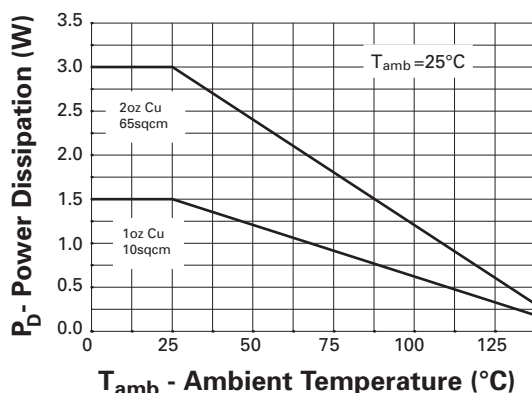

### DFN832

Single die on 1.5W devices

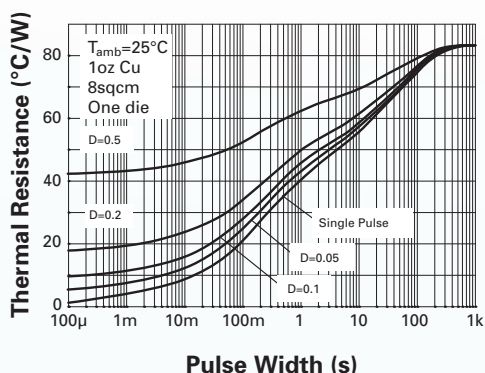

$\theta_{j-a} = 83^{\circ}\text{C/W}$  maximum.

Mounted on an FR4 pcb with 28mm x 28mm coverage of single sided 2oz weight copper in still air conditions.

Derating curve

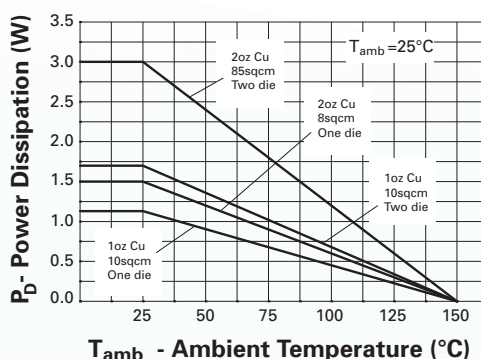

### E-Line

1.2W devices

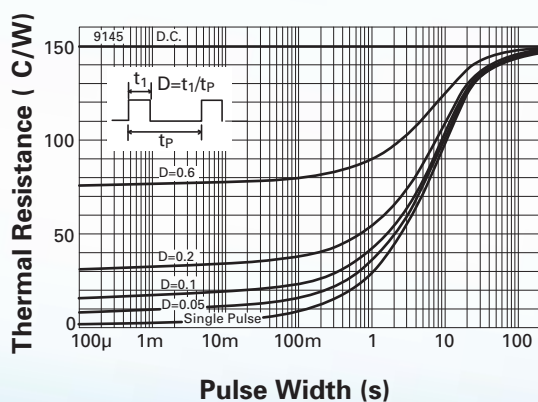

$\theta_{j-a} = 150^{\circ}\text{C/W}$  maximum.

Through hole mounted on an FR4 pcb with a 25mm x 25mm coverage of single sided 1oz weight copper, in still air conditions, leg length 4mm.

Derating curves

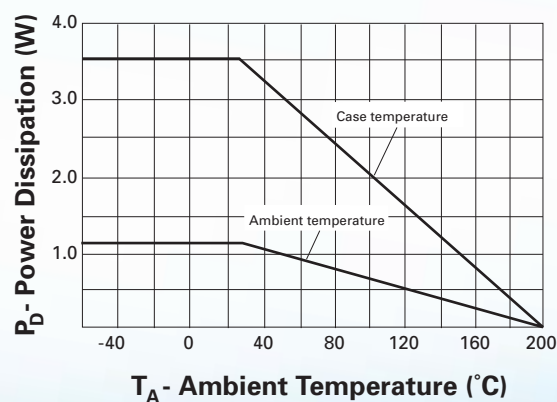

# DPAK

## 2.1W devices

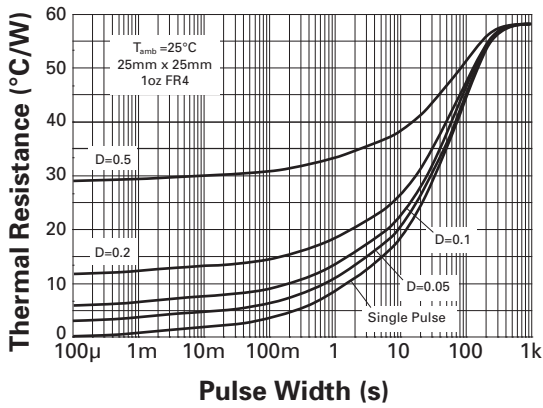

$\theta_{j-a} = 59^\circ\text{C/W}$  maximum.

Mounted on an FR4 pcb of 25mm x 25mm x 1.6mm with high coverage of single sided 1oz weight copper, in still air conditions.

## Derating curves

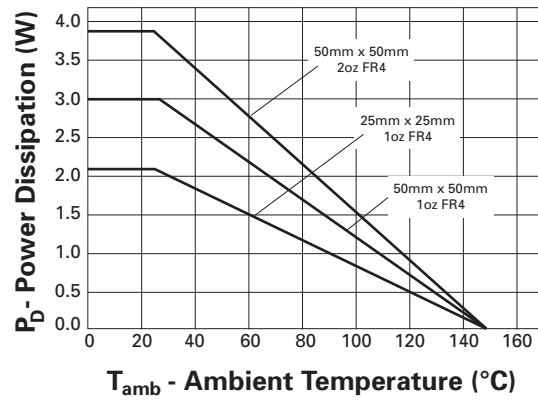

## 3.9W devices

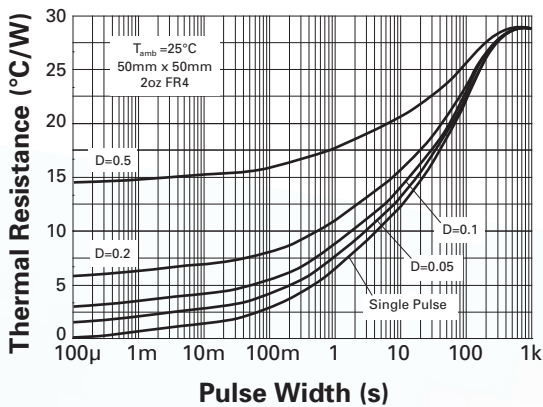

$\theta_{j-a} = 32^\circ\text{C/W}$  maximum.

Mounted on an FR4 pcb of 50mm x 50mm x 1.6mm with high coverage of single sided 2oz weight copper, in still air conditions.

# MSOP8

## One active die 0.87W devices

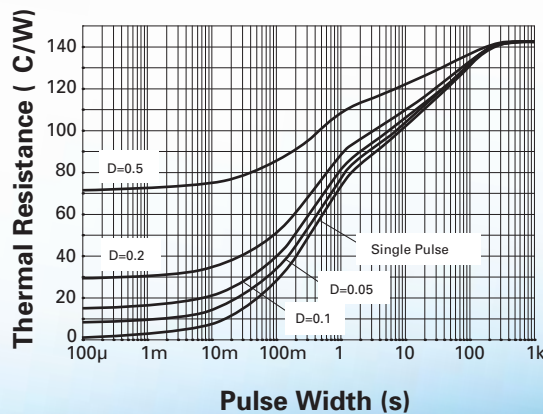

$\theta_{j-a} = 143^\circ\text{C/W}$  maximum.

One active die. Mounted on 25mm x 25mm x 1.6mm FR4 pcb with high coverage of single sided 1oz weight copper, in still air conditions.

## Derating curve

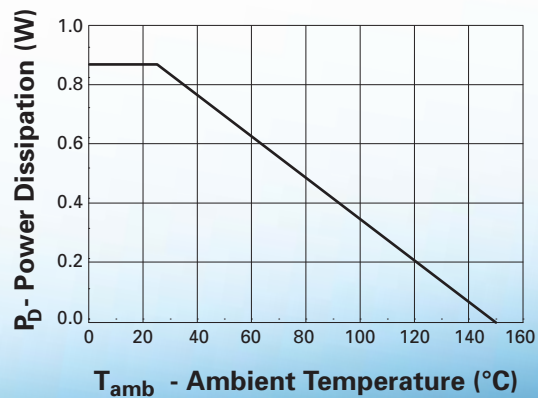

# SM8 dual

## Single die on 2.25W devices

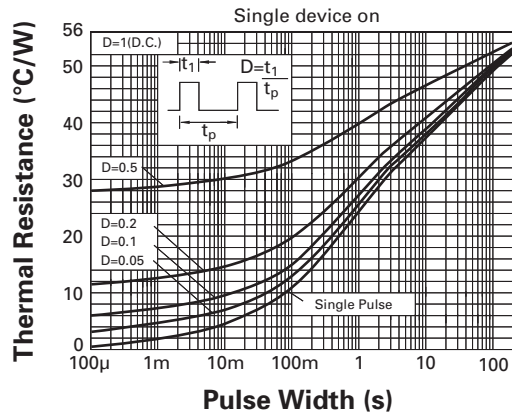

$\Theta_{j-a}$ =55.6°C/W maximum.

## Derating curves

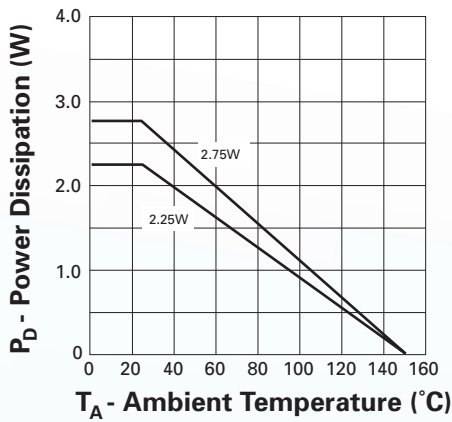

Mounted on a 50mm x 50mm x 1.6mm FR4 pcb with a high coverage of single sided 2oz weight copper, in still air conditions.

## Both die on equally, total power 2.75W

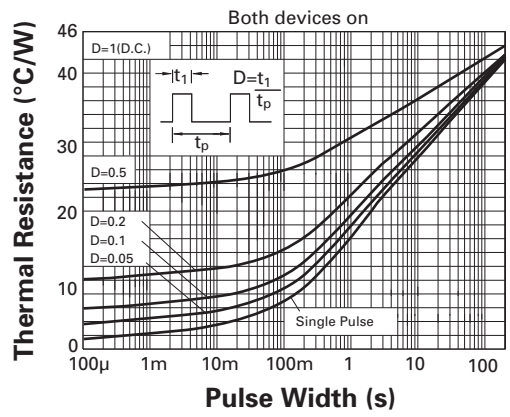

$\Theta_{j-a}$ =45.6°C/W maximum.

# SOD323

## 330mW devices

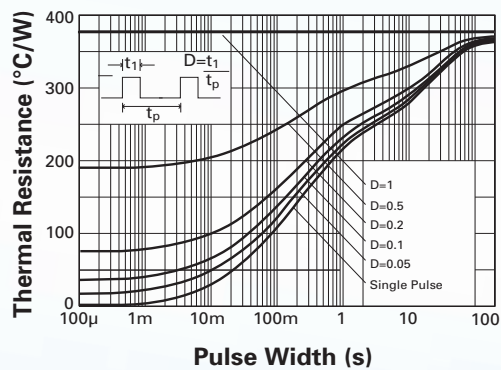

$\Theta_{j-a}$ =380°C/W.

Mounted on 10mm x 8mm x 1.6mm FR4 pcb with high coverage of 1oz weight copper in still air conditions.

## Derating curve

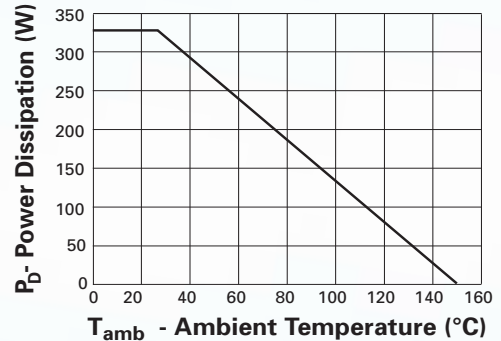

# SOD523

360mW devices

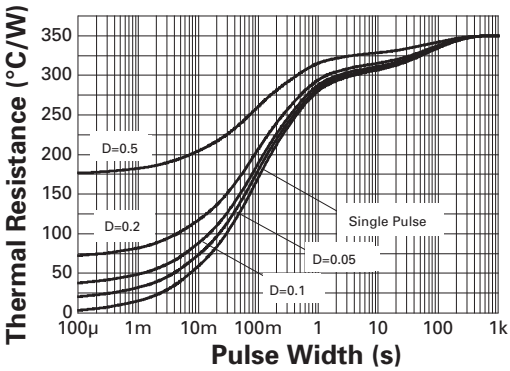

$\Theta_{j-a}=350^{\circ}\text{C/W}$ .

Mounted on 25mm x 25mm x 1.6mm FR4 pcb with high coverage of 1oz weight copper, in still air conditions.

Derating curve

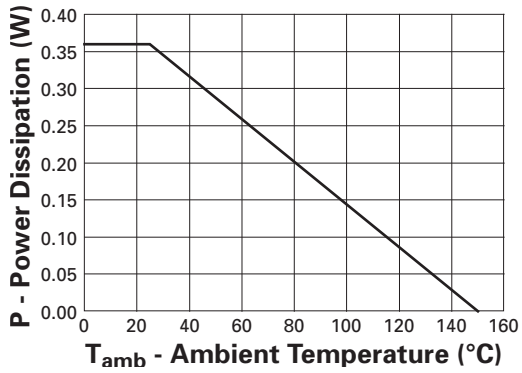

# S08 dual

Single die on 1.25W devices

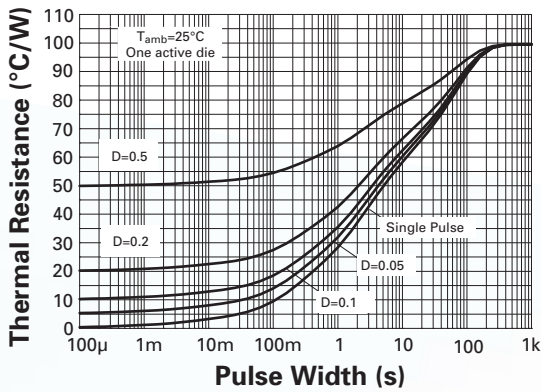

$\Theta_{j-a}=100^{\circ}\text{C/W}$  maximum.

Both die on equally, total power 1.75W

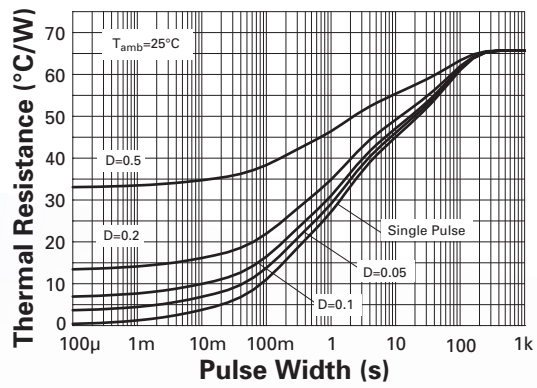

$\Theta_{j-a}=69^{\circ}\text{C/W}$  maximum.

Derating curves

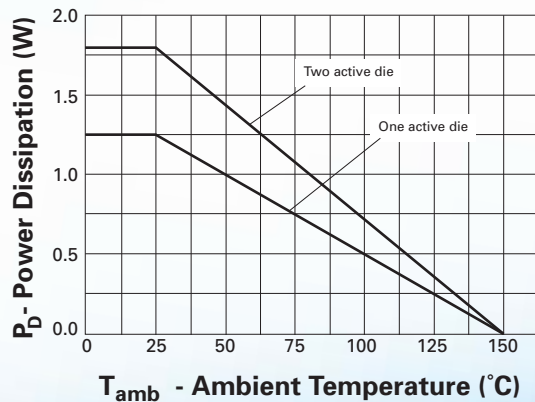

Mounted on 25mm x 25mm x 1.6mm FR4 pcb with full coverage of single sided 1oz weight copper, in still air conditions.

# SOT223

2W devices

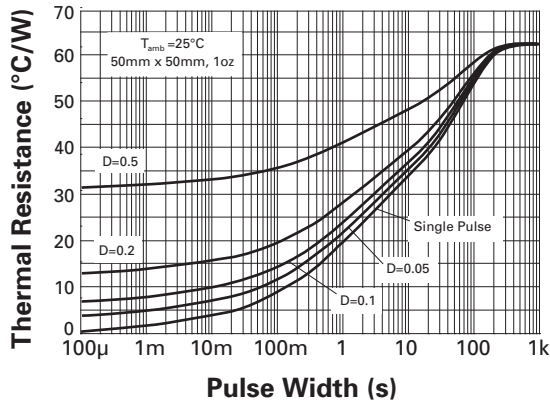

$\theta_{j-a}$ =62.5°C/W maximum.

Mounted on an FR4 pcb with 50mm x 50mm of single sided 1oz weight copper, in still air conditions.

Derating curve

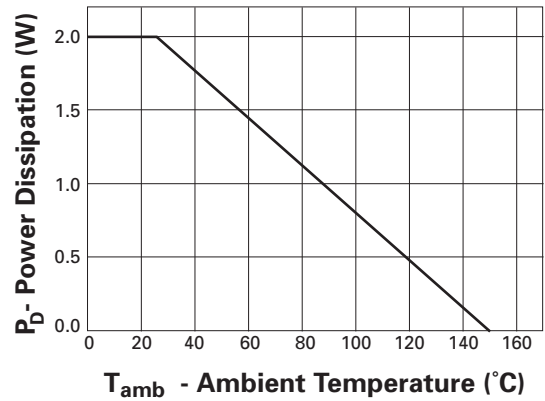

3W devices

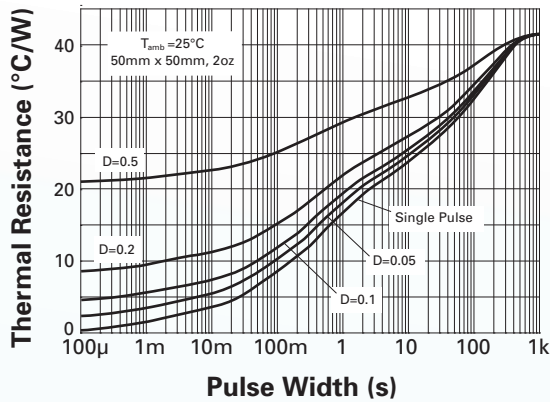

$\theta_{j-a}$ =41.7°C/W maximum.

Mounted on 50mm x 50mm single sided 2oz weight copper, in still air conditions.

Derating curve

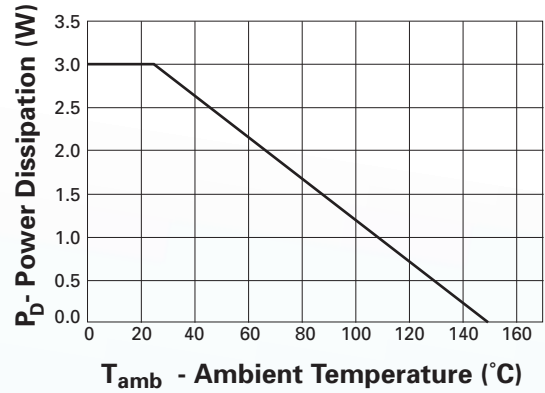

# SOT23-6

1.1W devices

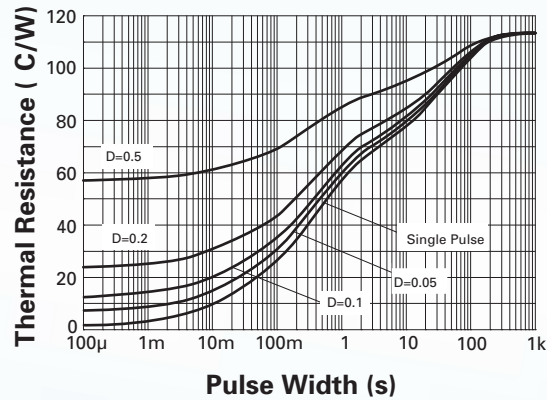

$\theta_{j-a}$ =113°C/W maximum.

Mounted on 25mm x 25mm x 1.6mm FR4 pcb with high coverage of single sided 1oz copper, in still air conditions.

Derating curve

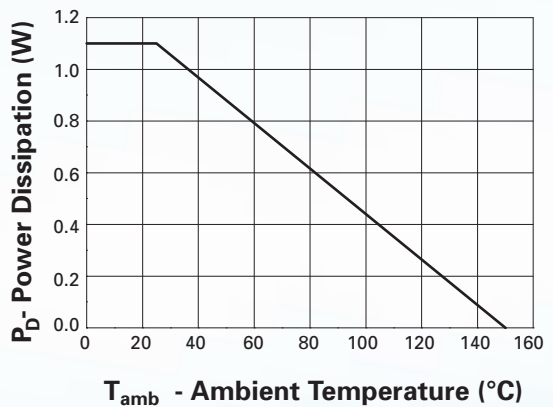

# SOT23

## 350mW devices

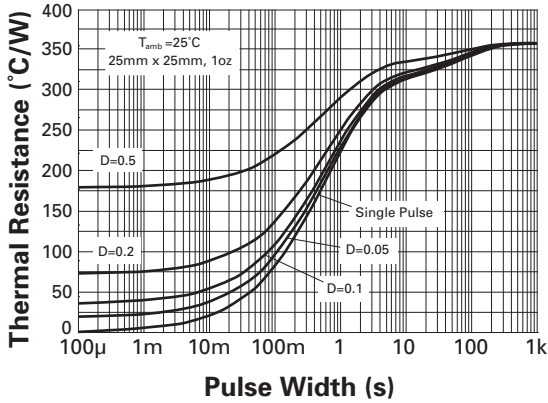

$\theta_{j-a}$ =350°C/W maximum.

Mounted on a 25mm x 25mm x 1.6mm FR4 pcb with high coverage of single sided 1oz weight copper, in still air conditions.

## Derating curve

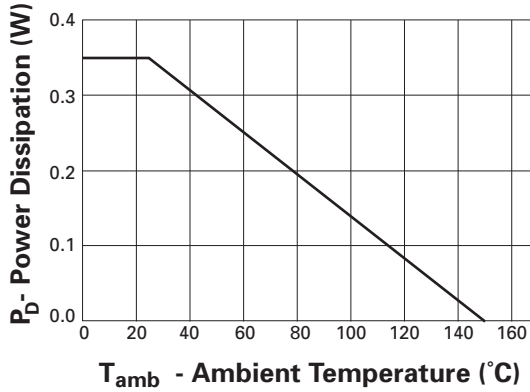

## 625mW devices

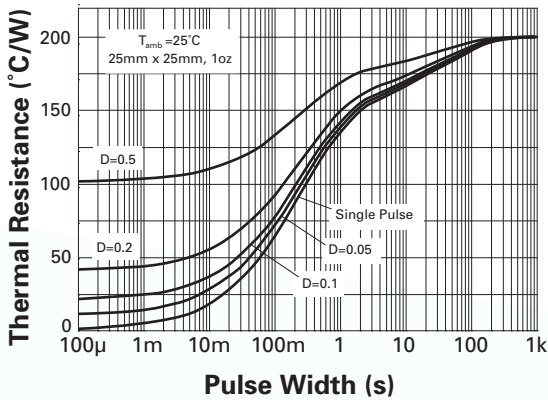

$\theta_{j-a}$ =200°C/W maximum.

Mounted on a 25mm x 25mm x 1.6mm FR4 pcb with high coverage of single sided 1oz weight copper, in still air conditions.

## Derating curve

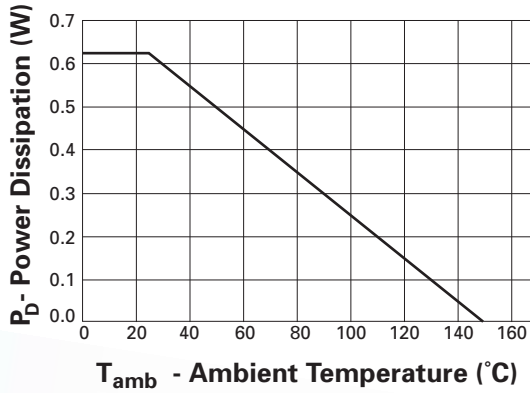

## 1.25W devices

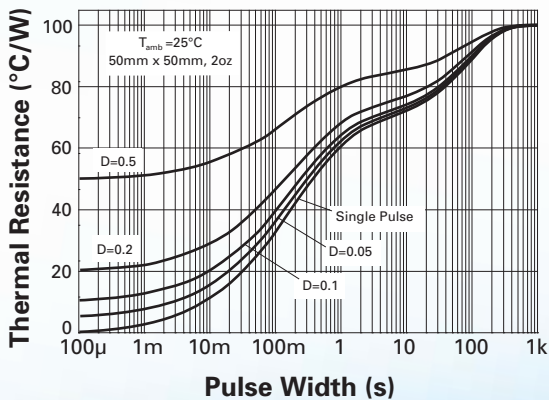

$\theta_{j-a}$ =100°C/W maximum.

Mounted on a 50mm x 50mm x 1.6mm FR4 pcb with high coverage of single sided 2oz weight copper, in still air conditions.

## Derating curves

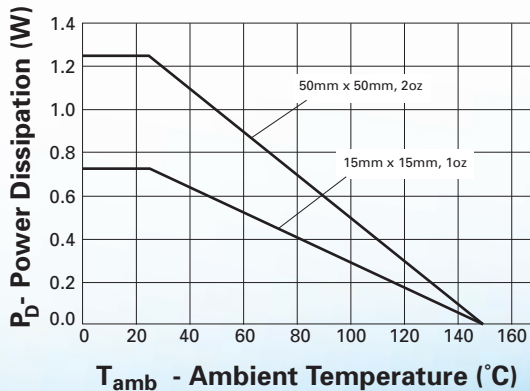

# SOT323

385mW devices

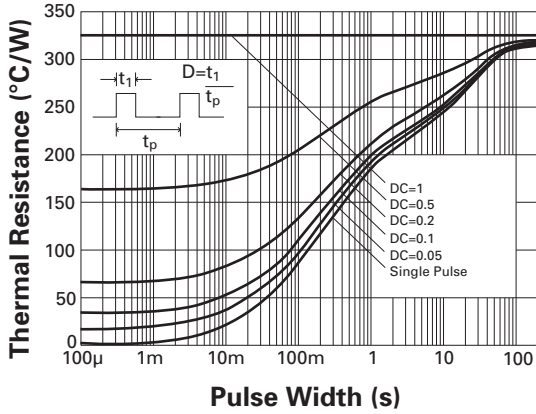

$\Theta_{j-a}=325^{\circ}\text{C/W}$

Mounted on 10mm x 8mm x 1.6mm FR4 pcb with high coverage of 1oz weight copper in still air conditions.

Derating curve

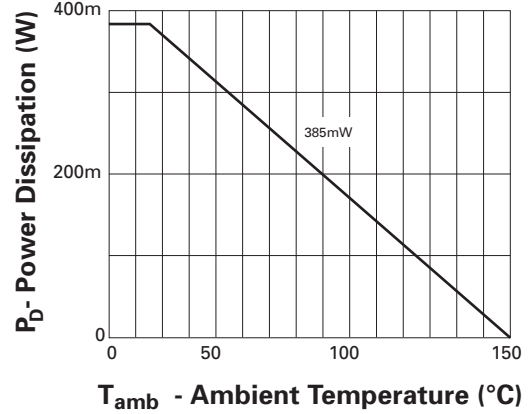

# SOT89

1W devices

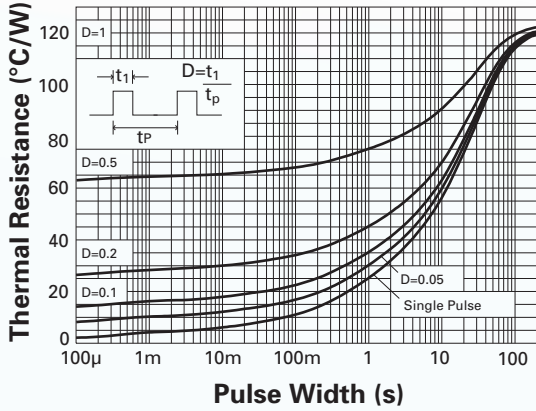

$\Theta_{j-a}=125^{\circ}\text{C/W}$  maximum,  $\Theta_{j-tab}=10^{\circ}\text{C/W}$  typical.

Mounted on a 15mm x 15mm x 1.6mm FR4 pcb with a high coverage of single sided 1oz weight copper, in still air conditions.

Derating curve

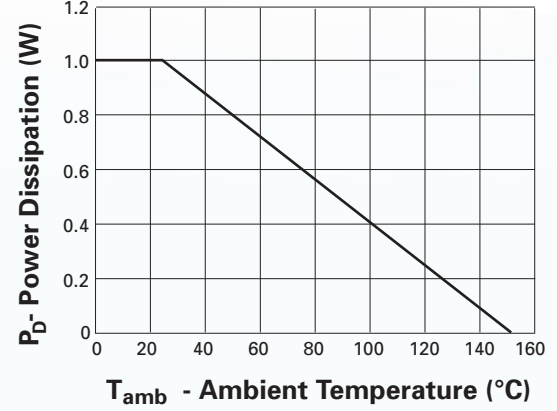



# SOT23F

## Transient Thermal Impedance

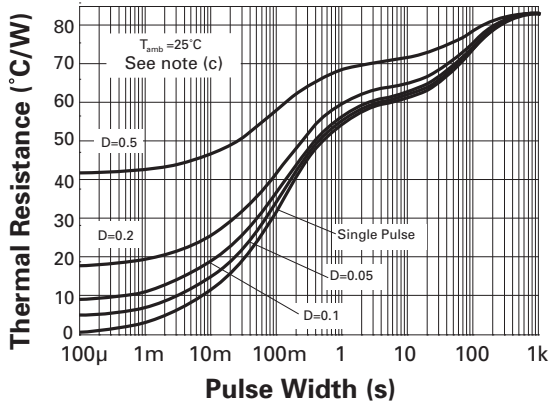

## Derating curve

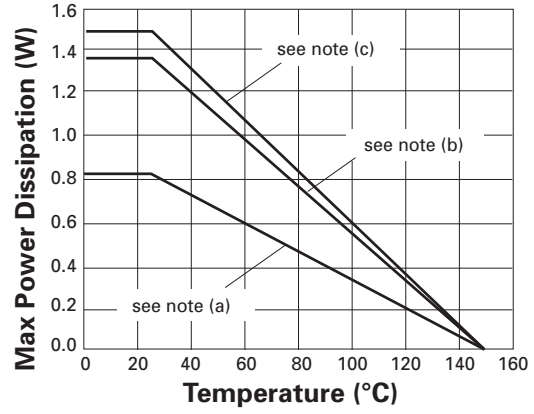

- (a) For a device surface mounted on 15mm x 15mm x 1.6mm FR4 PCB with high coverage of single sided 1oz copper, in still air conditions.
- (b) Mounted on 25mm x 25mm x 1.6mm FR4 PCB with a high coverage of single sided 2oz copper in still air conditions.
- (c) Mounted on 50mm x 50mm x 1.6mm FR4 PCB with a high coverage of single sided 2oz copper in still air conditions.

# Alphanumeric index

## Section 10.0

2N7002 .....45

### B

Back-Off Diodes .....40

BAT1000 .....38

BAT54 .....38

BAT54A .....38

BAT54C .....38

BAT54S .....38

BAT750 .....38

BCV47 .....28

BCV49 .....28

BCW66H .....17

BCW68H .....19

BCX38C .....28

BCX5316 .....22

BCX5616 .....21

BCX6825 .....12

BCX6925 .....15

BS107P .....49

BS250F .....44

BS250P .....44

BSP75G .....47

BSP75N .....47

BSR33 .....22

BSR43 .....21

BSS123 .....48

BSS123A .....48

BSS138 .....43

BSS84 .....44

BST39 .....26

BST52 .....28

BYP53/54 .....40

BYP57/58 .....40

BYY53/54 .....40

BYY57/58 .....40

BYY57A/58A .....40

BZP61/62 .....40

BZP63/64 .....40

BZV61/62 .....40

BZV63/64 .....40

### F

FCX1047A .....10

FCX1051A .....16

FCX1053A .....20

FCX1147A .....13

FCX1149A .....15

FCX1151A .....18

FCX458 .....26

FCX491 .....20

FCX491A .....16

FCX493 .....21

FCX495 .....24

FCX555 .....25

FCX558 .....27

FCX589 .....18

FCX591 .....22

FCX591A .....19

FCX593 .....23

FCX596 .....25

FCX605 .....28

FCX617 .....10

FCX619 .....17

FCX658A .....26

FCX688B .....10

FCX690B .....16

FCX705 .....28

FCX717 .....13

FCX718 .....14

FCX789A .....15

FCX790A .....19

FMMT38C .....28

FMMT413 .....28

FMMT415 .....28

FMMT417 .....28

FMMT449 .....16

FMMT451 .....20

FMMT455 .....24

FMMT458 .....26

FMMT459 .....26

FMMT489 .....16

FMMT491 .....20

FMMT491A .....16

FMMT493 .....21

FMMT493A .....20

FMMT494 .....24

FMMT495 .....24

FMMT497 .....26

FMMT549 .....18

FMMT549A .....18

FMMT551 .....22

FMMT555 .....25

FMMT558 .....27

FMMT560 .....27

FMMT589 .....18

FMMT591 .....22

FMMT591A .....19

FMMT593 .....23

FMMT596 .....25

FMMT597 .....27

FMMT614 .....28

FMMT617 .....10

FMMT618 .....11

FMMT619 .....17

FMMT620 .....21

FMMT624 .....24

FMMT625 .....24

FMMT634 .....28

FMMT6517 .....26

FMMT6520 .....27

FMMT717 .....13

FMMT718 .....15

FMMT720 .....19

FMMT722 .....22

FMMT723 .....23

FMMT734 .....28

FMMTA06 .....21

FMMTA13 .....28

FMMTA14 .....28

FMMTA42 .....26

FMMTA56 .....23

FMMTA92 .....27

FMMTL618 .....11

FMMTL619 .....17

FMMTL717 .....13

FMMTL718 .....15

FZT1047A .....10

FZT1048A .....10

FZT1049A .....12

FZT1051A .....16

FZT1053A .....20

FZT1147A .....13

FZT1149A .....15

FZT1151A .....18

FZT458 .....26

FZT489 .....16

FZT491.....	20	FZTA42 .....	26	ZHCS756 .....	38
FZT491A .....	16	FZTA92 .....	27	ZHT431 .....	59
FZT493.....	21	<b>L</b>		ZLDO330 .....	66
FZT549.....	18	LM4040-2.5 .....	61	ZLDO500 .....	66
FZT558.....	27	LM4040-3.0 .....	61	ZLLS1000 .....	38
FZT560.....	27	LM4040-5.0 .....	61	ZLLS2000 .....	38
FZT589.....	18	LM4041 .....	61	ZLLS350 .....	38
FZT591.....	22	<b>R</b>		ZLLS400 .....	38
FZT591A .....	19	Rectifier Stacks.....	40	ZLLS410 .....	38
FZT593.....	23	<b>S</b>		ZLLS500 .....	38
FZT600.....	28	SXTA42 .....	26	ZMR250 .....	64
FZT600B .....	28	<b>T</b>		ZMR330 .....	64
FZT603.....	28	TLV431 .....	59	ZMR500 .....	64
FZT605.....	28	<b>V</b>		ZMT32 .....	75
FZT649.....	12	VN10LP.....	45	ZMV832B.....	40
FZT651.....	20	<b>Z</b>		ZMV833B.....	40
FZT653.....	21	ZC831B.....	40	ZMV930 .....	39
FZT655.....	24	ZC832B.....	40	ZMV931 .....	39
FZT657.....	26	ZC833B.....	40	ZMV932 .....	39
FZT658.....	26	ZC834B.....	40	ZMV933 .....	39
FZT688B .....	10	ZC835B.....	40	ZMV933A.....	39
FZT689B .....	11	ZC836B.....	40	ZMV934 .....	39
FZT690B .....	16	ZC930 .....	39	ZMV934A.....	39
FZT692B .....	20	ZC931 .....	39	ZMY20M .....	75
FZT694B .....	24	ZC932 .....	39	ZMZ20M .....	75
FZT696B .....	24	ZC933 .....	39	ZNI1000 .....	74
FZT705.....	28	ZC933A.....	39	ZR285-2.5 .....	61
FZT717.....	13	ZC934 .....	39	ZR4040-2.5 .....	61
FZT749.....	15	ZC934A.....	39	ZR4040-4.1 .....	61
FZT751.....	22	ZDT1048.....	30	ZR4040-5 .....	61
FZT753.....	23	ZDT1049.....	30	ZR431 .....	59
FZT755.....	25	ZDT1053.....	30	ZR431L .....	59
FZT757.....	27	ZDT6718.....	30	ZRB500 .....	60
FZT758.....	27	ZDT6753.....	29	ZRC250 .....	60
FZT788B .....	14	ZDT6790.....	29	ZRC330 .....	60
FZT789A .....	15	ZDT694 .....	30	ZRC400 .....	60
FZT790A .....	18	ZDT749 .....	30	ZRC500 .....	60
FZT792A .....	22	ZDT751 .....	30	ZSD100 .....	74
FZT795A .....	25	ZDT795A.....	30	ZSM300 .....	73
FZT796A .....	25	ZHB6718.....	29	ZSM560 .....	73
FZT849.....	16	ZHB6790.....	29	ZSR300 .....	65
FZT851.....	20	ZHB6792.....	29	ZSR330 .....	65
FZT853.....	21	ZHCS1000 .....	38	ZSR500 .....	65
FZT855.....	24	ZHCS1006 .....	38	ZSR1000.....	65
FZT857.....	26	ZHCS2000 .....	38	ZTL431 .....	59
FZT869.....	12	ZHCS350 .....	38	ZTL432.....	59
FZT948.....	14	ZHCS400 .....	38	ZTX1048A.....	10
FZT949.....	18	ZHCS500 .....	38	ZTX1049A.....	12
FZT951.....	22	ZHCS506 .....	38	ZTX1051A.....	16
FZT953.....	23	ZHCS750 .....	38	ZTX1053A.....	20
FZT955.....	25			ZTX1147A.....	13
FZT956.....	25			ZTX1149A.....	15
FZT957.....	27			ZTX415 .....	28
FZT958.....	27			ZTX449 .....	16
FZT968.....	13			ZTX450 .....	17
FZTA14 .....	28			ZTX451 .....	20

ZTX453 .....	21	ZUMT491.....	20	ZVP3306F .....	46
ZTX455 .....	24	ZUMT591.....	22	ZVP3310A.....	49
ZTX457 .....	26	ZUMT617.....	10	ZVP3310F .....	49
ZTX458 .....	26	ZUMT618.....	11	ZVP4105A.....	44
ZTX549 .....	18	ZUMT619.....	17	ZVP4424A.....	50
ZTX550 .....	19	ZUMT717.....	13	ZVP4424G.....	50
ZTX551 .....	22	ZUMT718.....	15	ZVP4424Z .....	50
ZTX553 .....	23	ZUMT720.....	19	ZVP4525E6 .....	50
ZTX558 .....	27	ZVN0124A .....	49	ZVP4525G.....	50
ZTX560 .....	27	ZVN0545A .....	49	ZVP4525Z .....	50
ZTX601 .....	28	ZVN0545G .....	49	ZX3CD1S1M832.....	31
ZTX601B.....	28	ZVN2106A .....	45	ZX3CD2S1M832.....	31
ZTX603 .....	28	ZVN2106G .....	45	ZX3CD3S1M832.....	31
ZTX605 .....	28	ZVN2110A .....	48	ZX3CDBS1M832 .....	31
ZTX614 .....	28	ZVN2110G .....	48	ZX5T2E6 .....	14
ZTX618 .....	11	ZVN2120A .....	49	ZX5T3Z .....	18
ZTX649 .....	12	ZVN2120G .....	49	ZX5T851A.....	20
ZTX651 .....	20	ZVN3306A .....	45	ZX5T851G.....	20
ZTX653 .....	21	ZVN3306F.....	45	ZX5T853G.....	21
ZTX657 .....	26	ZVN3310A .....	48	ZX5T853Z .....	21
ZTX658 .....	26	ZVN3310F.....	48	ZX5T949G.....	18
ZTX688B.....	10	ZVN3320A .....	49	ZX5T951G.....	22
ZTX689B.....	11	ZVN3320F.....	49	ZX5T953G.....	23
ZTX690B.....	17	ZVN4106F.....	45	ZX5T955G.....	25
ZTX692B.....	20	ZVN4206A .....	45	ZX5T955Z .....	25
ZTX694B.....	24	ZVN4206AV .....	45	ZX5T1951G.....	22
ZTX696B.....	24	ZVN4206G .....	45	ZXCL250 .....	67
ZTX705 .....	28	ZVN4206GV .....	45	ZXCL280 .....	67
ZTX718 .....	14	ZVN4210A .....	48	ZXCL300 .....	67
ZTX749 .....	15	ZVN4210G .....	48	ZXCL330 .....	67
ZTX751 .....	22	ZVN4306A .....	45	ZXCL5213V25.....	67
ZTX753 .....	23	ZVN4306AV .....	45	ZXCL5213V28.....	67
ZTX757 .....	27	ZVN4306G .....	45	ZXCL5213V30.....	67
ZTX758 .....	27	ZVN4306GV .....	45	ZXCL5213V33.....	67
ZTX788A.....	14	ZVN4310A .....	48	ZXCT1008.....	54
ZTX788B.....	14	ZVN4310G .....	48	ZXCT1009.....	54
ZTX789A.....	15	ZVN4424A .....	49	ZXCT1010.....	54
ZTX790A.....	19	ZVN4424G .....	49	ZXCT1011.....	54
ZTX792A.....	22	ZVN4424Z .....	49	ZXCT1012.....	54
ZTX795A.....	25	ZVN4525E6.....	49	ZXCT1020.....	54
ZTX796A.....	25	ZVN4525G .....	49	ZXCT1021.....	56
ZTX849 .....	16	ZVN4525Z .....	49	ZXCT1022.....	56
ZTX851 .....	20	ZVNL110A .....	48	ZXCT1030.....	56
ZTX853 .....	21	ZVNL110G .....	48	ZXCT1032.....	56
ZTX855 .....	24	ZVNL120A .....	49	ZXCT1041.....	56
ZTX857 .....	26	ZVNL120G .....	49	ZXCT1050.....	54
ZTX869 .....	12	ZVP0545A .....	50	ZXCT1051.....	56
ZTX948 .....	14	ZVP0545G.....	50	ZXCT1080.....	56
ZTX949 .....	18	ZVP1320F .....	50	ZXCT1081.....	56
ZTX951 .....	22	ZVP2106A.....	46	ZXGD3001E6.....	32
ZTX953 .....	23	ZVP2106G.....	46	ZXGD3002E6.....	32
ZTX955 .....	25	ZVP2110A.....	49	ZXGD3003E6.....	32
ZTX956 .....	25	ZVP2110G.....	49	ZXGD3004E6.....	32
ZTX957 .....	27	ZVP2120A.....	50	ZXLD1601.....	69
ZTX958 .....	27	ZVP2120G.....	50	ZXLD1615.....	69
ZTX968 .....	13	ZVP3306A.....	46	ZM33164-3 .....	73

ZXM41N10F .....	48	ZXMN2F34FH .....	42	ZXMP6A13F .....	46
ZXM61N02F .....	42	ZXMN2F34MA .....	42	ZXMP6A13G .....	46
ZXM61N03F .....	43	ZXMN3A01E6 .....	43	ZXMP6A16DN8 .....	46
ZXM61P02F .....	42	ZXMN3A01F .....	43	ZXMP6A16K .....	46
ZXM61P03F .....	44	ZXMN3A02X8 .....	43	ZXMP6A17DN8 .....	46
ZXM62N02E6 .....	42	ZXMN3A03E6 .....	43	ZXMP6A17E6 .....	46
ZXM62N03G .....	43	ZXMN3A04DN8 .....	43	ZXMP6A17G .....	46
ZXM62P02E6 .....	42	ZXMN3A04K .....	43	ZXMP6A18DN8 .....	46
ZXM62P03E6 .....	44	ZXMN3A06DN8 .....	43	ZXMP6A18K .....	46
ZXM62P03G .....	44	ZXMN3A14F .....	43	ZXMP7A17G .....	46
ZXM64N02X .....	42	ZXMN3AM832 .....	43	ZXMP7A17K .....	46
ZXM64N035L3 .....	43	ZXMN3B01F .....	43	ZXMS6001G .....	47
ZXM64P02X .....	42	ZXMN3B14F .....	43	ZXMS6002G .....	47
ZXM64P035L3 .....	44	ZXMN3F30FH .....	43	ZXMS6003G .....	47
ZXM64P03X .....	44	ZXMN3F318DN8 .....	43	ZXMS6004FF .....	47
ZXMC3A17DN8 .....	44	ZXMN3F31DN8 .....	43	ZXMS6005G .....	47
ZXMC3AM832 .....	44	ZXMN3G32DN8 .....	43	ZXRE060 .....	59
ZXMC3F31DN8 .....	44	ZXMN4A06G .....	43	ZXRE1004 .....	60
ZXMC4559DN8 .....	46	ZXMN4A06K .....	43	ZXRE125 .....	60
ZXMC4A16DN8 .....	44	ZXMN6A07F .....	45	ZXRE4041 .....	61
ZXMC6A09DN8 .....	46	ZXMN6A07Z .....	45	ZXSB1000QT8 .....	39
ZXMD63C02X .....	43	ZXMN6A08E6 .....	45	ZXSBMR16PT8 .....	39
ZXMD63C03X .....	44	ZXMN6A08G .....	45	ZXSC100 .....	70
ZXMD63N02X .....	42	ZXMN6A09DN8 .....	45	ZXSC410 .....	70
ZXMD63N03X .....	43	ZXMN6A09G .....	45	ZXSC420 .....	70
ZXMD63P02X .....	42	ZXMN6A09K .....	45	ZXSC440 .....	70
ZXMD63P03X .....	44	ZXMN6A11DN8 .....	45	ZXSD500E6 .....	38
ZXMHC10A07T8 .....	49	ZXMN6A11G .....	45	ZXSDS2M832 .....	38
ZXMHC3A01T8 .....	44	ZXMN6A11Z .....	45	ZXT1053AK .....	20
ZXMHC6A07T8 .....	46	ZXMN6A25DN8 .....	45	ZXT10N15DE6 .....	10
ZXMHN6A07T8 .....	46	ZXMN6A25G .....	45	ZXT10N20DE6 .....	11
ZXMN0545FF .....	49	ZXMN6A25K .....	45	ZXT10N50DE6 .....	17
ZXMN0545G4 .....	49	ZXMN6A25N8 .....	45	ZXT10P12DE6 .....	13
ZXMN10A07F .....	48	ZXMN7A11G .....	45	ZXT10P20DE6 .....	15
ZXMN10A07Z .....	48	ZXMN7A11K .....	45	ZXT10P40DE6 .....	19
ZXMN10A08DN8 .....	48	ZXMP10A13F .....	49	ZXT11N15DF .....	10
ZXMN10A08E6 .....	48	ZXMP10A16K .....	49	ZXT11N20DF .....	11
ZXMN10A08G .....	48	ZXMP10A17E6 .....	49	ZXT12N20DX .....	30
ZXMN10A09K .....	48	ZXMP10A17K .....	49	ZXT12N50DX .....	30
ZXMN10A11G .....	48	ZXMP10A18G .....	49	ZXT12P12DX .....	30
ZXMN10A11K .....	48	ZXMP10A18K .....	49	ZXT12P40DX .....	30
ZXMN10A25G .....	48	ZXMP2120E5 .....	50	ZXT13N15DE6 .....	10
ZXMN10A25K .....	48	ZXMP2120FF .....	50	ZXT13N20DE6 .....	11
ZXMN10B08E6 .....	48	ZXMP2120G4 .....	50	ZXT13N50DE6 .....	17
ZXMN20866DE6 .....	42	ZXMP3A13F .....	44	ZXT13P12DE6 .....	13
ZXMN2A01E6 .....	42	ZXMP3A16DN8 .....	44	ZXT13P20DE6 .....	14
ZXMN2A01F .....	42	ZXMP3A16G .....	44	ZXT13P40DE6 .....	18
ZXMN2A02X8 .....	42	ZXMP3A16N8 .....	44	ZXT1M322 .....	13
ZXMN2A03E6 .....	42	ZXMP3A17DN8 .....	44	ZXT2M322 .....	14
ZXMN2A04DN8 .....	42	ZXMP3A17E6 .....	44	ZXT3M322 .....	18
ZXMN2A14F .....	42	ZXMP3F30FH .....	44	ZXT4M322 .....	22
ZXMN2AM832 .....	42	ZXMP3F36N8 .....	44	ZXT690BK .....	16
ZXMN2B01F .....	42	ZXMP3F37DN8 .....	44	ZXT790AK .....	18
ZXMN2B03E6 .....	42	ZXMP3G35N8 .....	44	ZXT849K .....	16
ZXMN2B14FH .....	42	ZXMP4A16G .....	44	ZXT951K .....	22
ZXMN2F30FH .....	42	ZXMP4A16K .....	44	ZXT953K .....	23

ZXTAM322.....	10	ZXTN25015DFH.....	10	ZXTP2039F.....	22
ZXTBM322.....	11	ZXTN25020BFH.....	11	ZXTP2041F.....	19
ZXTC2045E6.....	29	ZXTN25020CFH.....	11	ZXTP23015CFH.....	13
ZXTC2061E6.....	29	ZXTN25020DFH.....	11	ZXTP23140BFH.....	25
ZXTC2062E6.....	29	ZXTN25020DFL.....	11	ZXTP25012EFH.....	13
ZXTC2063E6.....	29	ZXTN25020DG.....	11	ZXTP25012EZ.....	13
ZXTCM322.....	17	ZXTN25020DZ.....	11	ZXTP25015DFH.....	13
ZXTD09N50DE6.....	30	ZXTN25040DFH.....	16	ZXTP25020BFH.....	14
ZXTD1M832.....	30	ZXTN25040DFL.....	16	ZXTP25020CFF.....	14
ZXTD2M832.....	30	ZXTN25040DZ.....	16	ZXTP25020CFH.....	14
ZXTD2075E6.....	30	ZXTN25050DFH.....	17	ZXTP25020DFH.....	14
ZXTD4591AM832.....	29	ZXTN25060BFH.....	20	ZXTP25020DFL.....	15
ZXTD4591E6.....	29	ZXTN25060BZ.....	20	ZXTP25020DG.....	14
ZXTD6717E6.....	29	ZXTN25100BFH.....	21	ZXTP25020DZ.....	14
ZXTDAM832.....	30	ZXTN25100DFH.....	21	ZXTP25040DFH.....	18
ZXTDA1M832.....	29	ZXTN5551EFL.....	24	ZXTP25040DFL.....	19
ZXTDBM832.....	30	ZXTN5551EG.....	24	ZXTP25040DZ.....	18
ZXTDB2M832.....	29	ZXTN5551EZ.....	24	ZXTP25060BFH.....	22
ZXTDCM832.....	30	ZXTN5551FL.....	24	ZXTP25100BFH.....	23
ZXTDC3M832.....	29	ZXTN5551G.....	24	ZXTP25100CFH.....	23
ZXTDE4M832.....	29	ZXTN5551Z.....	24	ZXTP25100CZ.....	23
ZXTEM322.....	21	ZXTP05120HFF.....	28	ZXTP25140BFH.....	25
ZXTN04120HFF.....	28	ZXTP03200BG.....	25		
ZXTN07012EFF.....	10	ZXTP5401EFL.....	25		
ZXTN07045EFF.....	16	ZXTP5401EG.....	25		
ZXTN08400BFF.....	26	ZXTP5401EZ.....	25		
ZXTN19020CFF.....	10	ZXTP5401FL.....	25		
ZXTN19020DFF.....	11	ZXTP5401G.....	25		
ZXTN19020DG.....	10	ZXTP5401Z.....	25		
ZXTN19020DZ.....	11	ZXTP07012EFF.....	13		
ZXTN19055DZ.....	20	ZXTP07040DFF.....	18		
ZXTN19060CFF.....	20	ZXTP08400BFF.....	27		
ZXTN19060CG.....	20	ZXTP19020CFF.....	14		
ZXTN19100CFF.....	21	ZXTP19020DFF.....	14		
ZXTN19100CG.....	21	ZXTP19020DG.....	14		
ZXTN19100CZ.....	21	ZXTP19020DZ.....	14		
ZXTN19100DG.....	21	ZXTP19060CFF.....	22		
ZXTN19100DZ.....	21	ZXTP19060CG.....	22		
ZXTN2005G.....	12	ZXTP19060CZ.....	22		
ZXTN2005Z.....	12	ZXTP19100CFF.....	23		
ZXTN2007G.....	16	ZXTP19100CG.....	23		
ZXTN2007Z.....	16	ZXTP19100CZ.....	23		
ZXTN2010A.....	20	ZXTP2006E6.....	14		
ZXTN2010G.....	20	ZXTP2008G.....	18		
ZXTN2010Z.....	20	ZXTP2008Z.....	18		
ZXTN2011G.....	21	ZXTP2009Z.....	18		
ZXTN2011Z.....	21	ZXTP2012A.....	22		
ZXTN2018F.....	20	ZXTP2012G.....	22		
ZXTN2020F.....	21	ZXTP2012Z.....	22		
ZXTN2031F.....	17	ZXTP2013G.....	23		
ZXTN2038F.....	20	ZXTP2013Z.....	23		
ZXTN2040F.....	16	ZXTP2014G.....	25		
ZXTN23015CFH.....	10	ZXTP2014Z.....	25		
ZXTN25012EFH.....	10	ZXTP2025F.....	19		
ZXTN25012EFL.....	10	ZXTP2027F.....	22		
ZXTN25012EZ.....	10	ZXTP2029F.....	23		





## About Zetex

Zetex Semiconductors designs and manufactures high performance semiconductor solutions for analog signal processing and the management of power in automotive, communications, consumer and industrial electronics.

Meeting the demand for greater power economy, precision and speed in analog circuit design, the broad Zetex product range comprises Smart application specific linear ICs and discrete semiconductor devices in multiple package configurations.

Emphasizing its ongoing commitment to quality, the standard IC products are supported by an ISO/TS16949:2002 quality management system that drives quality of both product and service from design through to manufacture. This high class of quality is further supplemented with product reliability that meets the requirements of the AECQ standards.

A keen advocate of reduction in environmental impact, Zetex parts meet all current legislation with improvements driven by conformance with the ISO14001 environmental standard.

For more comprehensive product details and up to the minute information on the complete range of discrete devices visit [www.zetex.com](http://www.zetex.com).



Zetex Semiconductors is committed to protecting the environment and compliance with all relevant national and international legislation. Zetex products are fully compliant with the European Union's RoHS directive (2002/95/EC). For further information visit [www.zetex.com/leadfree](http://www.zetex.com/leadfree).

## Europe

**Zetex GmbH**  
Kustermann-Park  
Balanstraße 59  
D-81541 München  
Germany  
Tel: (49) 89 45 49 49 0  
Fax: (49) 89 45 49 49 49  
Email: [europe.sales@zetex.com](mailto:europe.sales@zetex.com)

## Americas

**Zetex Inc**  
700 Veterans Memorial Highway  
Hauppauge, NY 11788  
USA  
Tel: (1) 631 360 2222  
Fax: (1) 631 360 8222  
Email: [usa.sales@zetex.com](mailto:usa.sales@zetex.com)

## Asia Pacific

**Zetex (Asia) Ltd**  
3701-04 Metroplaza Tower 1  
Hing Fong Road, Kwai Fong  
Hong Kong  
Tel: (852) 2610 0611  
Fax: (852) 2425 0494  
Email: [asia.sales@zetex.com](mailto:asia.sales@zetex.com)

## Corporate Headquarters

**Zetex Semiconductors plc**  
Zetex Technology Park  
Chadderton  
Oldham, OL9 9LL  
United Kingdom  
Tel: (44) 161 622 4444  
Fax: (44) 161 622 4446  
Email: [hq@zetex.com](mailto:hq@zetex.com)  
[www.zetex.com](http://www.zetex.com)

For international sales offices visit [www.zetex.com/offices](http://www.zetex.com/offices)  
Zetex products are distributed worldwide. For details see [www.zetex.com/salesnetwork](http://www.zetex.com/salesnetwork)